

Crystal City Metrorail Station Second Entrance Conceptual Design and Feasibility Study

Basis of Concept Report (BOCR) and Refined Conceptual Design Plans

Final Report

Arlington County, Virginia
November 2019

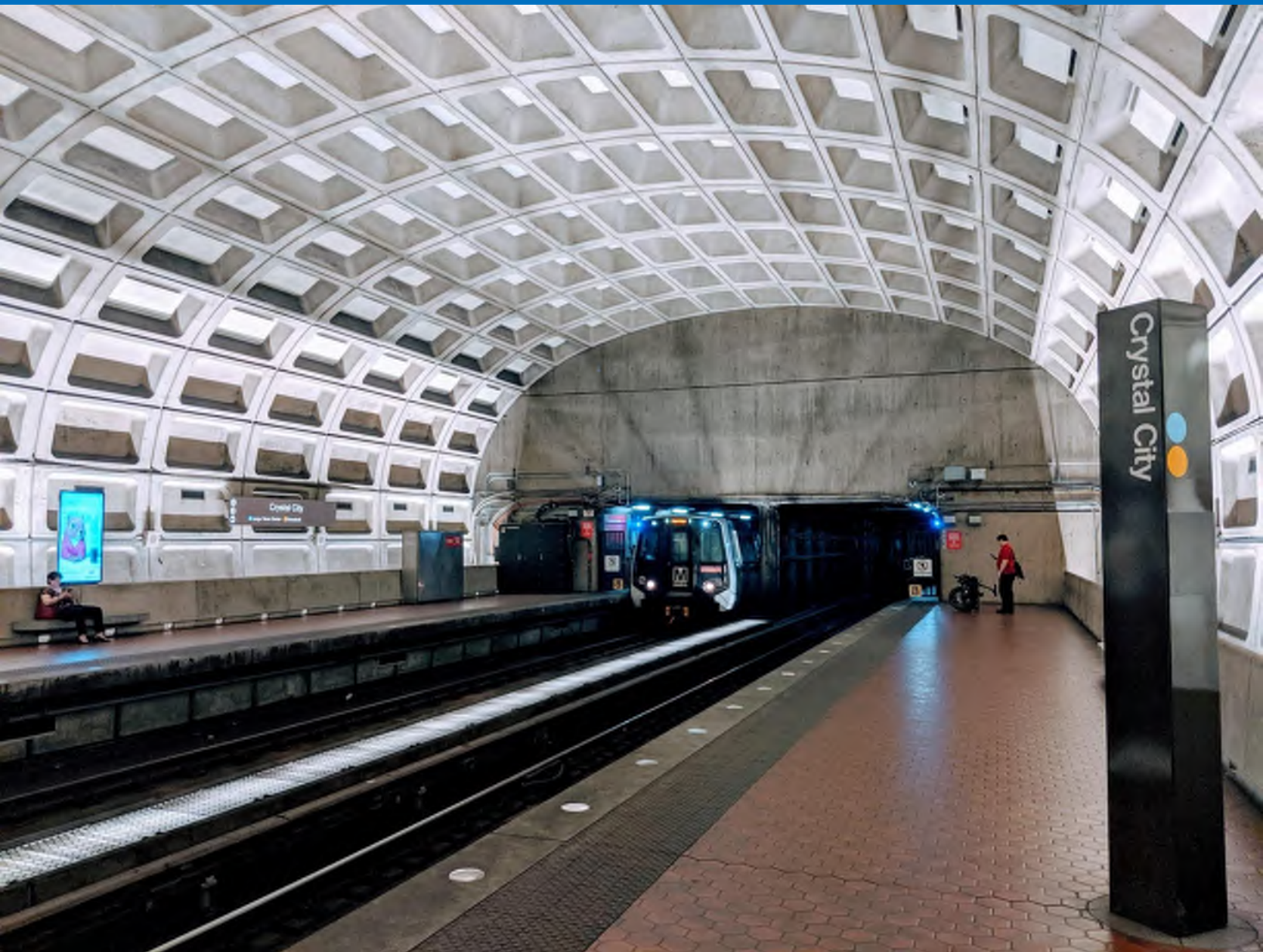

(This page left intentionally blank)

Crystal City Metrorail Station Second Entrance Conceptual Design and Feasibility Study

Basis of Concept Report (BOCR) and Refined Conceptual Design Plans

November 2019



Lead Agency

Washington Metropolitan Area Transit Authority
Office of Planning
600 5th Street NW
Washington, DC 20001

Shyam Kannan, Vice President of Planning
Robin McElhenny, Program Manager of Station Planning
Sara Benson, Project Manager



Arlington County

Arlington County Division of Transportation
2100 Clarendon Boulevard, Suite 900
Arlington, VA 22201

Dennis Leach, Deputy Director of Transportation
Blanche Buergler, Transit Capital Program Manager

(This page left intentionally blank)

Table of Contents

Executive Summary	ES-1
1 Introduction	1
1.1 Study Purpose and Overview.....	1
1.2 Background.....	1
2 Design Refinements and Initial Engineering Assessment	6
2.1 Design Refinements.....	6
3 Refined Second Entrance Conceptual Design	9
4 Engineering Feasibility Assessment of Refined Design Concept	23
4.1 Utilities	23
4.2 Geotechnical and Structural Analysis.....	24
4.3 Mechanical Systems	33
4.4 Electrical Systems.....	37
4.5 Communications	38
4.6 Egress Analysis	38
5 Constructability	40
5.1 Constructability Review.....	41
5.2 Sequence of Construction.....	45
5.3 Implementation Considerations.....	46
6 Schedule	48
6.1 Schedule Drivers.....	49

Figures

Figure 1 Crystal City Second Entrance Location Map	2
Figure 2 Amazon Headquarters at National Landing, Virginia	4
Figure 3 JBG Smith Central District Redevelopment (Rendering)	5
Figure 4 Design Refinement Process.....	6
Figure 5 Partial Plan of Existing Roof Framing	8
Figure 6 Relocated Access Stairwell	9
Figure 7 Refined Concept Plan: Vicinity Plan	11
Figure 8 Refined Concept Design Plan: Demolition Plans	12
Figure 9 Refined Concept Design Plan: Street Level.....	13
Figure 10 Refined Concept Design Plan: Mezzanine Second Level	14
Figure 11 Refined Concept Design Plan: New Mezzanine Floor Plan	15
Figure 12 Refined Concept Design Plan: Platform Level Floor Plan.....	16
Figure 13 Refined Concept Design Plan: Mezzanine and Building Sections.....	17
Figure 14 Refined Concept Design Plan: Tunnel and Building Section.....	18
Figure 15 Refined Concept Design Plan: Cross Section Thru Tunnel.....	19
Figure 16 Refined Concept Design Plan: Mezzanine 3D View	20
Figure 17 Refined Concept Design Plan: Site 3D View	21

Figure 18 Existing Utilities	24
Figure 19 Existing Soil Conditions	25
Figure 20 Cross Section of Existing Crystal City East Service Room Structure	27
Figure 21 Cross Section of Typical Vault Arch	28
Figure 22 Partial Plan of Train Room on Outbound Track Side	30
Figure 23 Second Level Plan of East Service Structure	32
Figure 24 Passageway Ceiling Clearance for Duct Work	33
Figure 25 Reconfigured East Service Room.....	34
Figure 26 Reconfigured Sewage Ejector Room (Platform Level).....	36
Figure 27 Adjacent parking garage entrance.....	42
Figure 28 Adjacent Foundation and Structures	43
Figure 29 Structural Modifications for Openings Inside of Station.....	43
Figure 30 Overview of Construction Sequence	45

Tables

Table 1 Existing Utilities	23
Table 2 Estimate of Electrical Load Added to the Station	38
Table 3 NFPA-130 Time-Egress Spreadsheet Calculations – Summary Table	39
Table 4 Major Project Elements Driving Schedule, Cost, and Risk.....	40
Table 5 Overview of Construction Schedule.....	48

Appendices

- Appendix A – Previously Recommended Crystal City Second Entrance Concept Design
- Appendix B – Future Ridership Demand and Pedestrian Simulation Results
- Appendix C – Detailed Egress Analysis and Spreadsheet Calculations
- Appendix D – Detailed Conceptual Project Schedule

Executive Summary

Introduction and Background

The Crystal City Metrorail station is located on the Metrorail Blue and Yellow lines in the Crystal City neighborhood in Arlington County, Virginia. The Crystal City Metrorail station is surrounded by high-density residential buildings, office buildings, and retail development. Ronald Reagan Washington National Airport (DCA) is located east of Crystal City, the Pentagon lies immediately to the north, Pentagon City is to the west, and Potomac Yard is to the south.

Crystal City has become an important multimodal hub in the region; transit options include Metrorail, commuter bus and rail, and premium bus service in dedicated bus lanes. Crystal City is served by Virginia Railway Express (VRE) – a commuter rail service that connects the Northern Virginia suburbs to Union Station in Washington, DC. The Crystal City VRE Station is located approximately 1,100 feet east from the existing Metrorail station entrance.

In 2010, Arlington County adopted the Crystal City Sector Plan that has planned for total floor area in the vicinity of the station to grow by approximately 61 percent by 2050, nearly all of it within easy walking distance of Crystal City Metrorail station. The Crystal City Sector Plan at build-out (2050) will include 57,400 workers with 15.9 million square feet of office inventory.

In November 2018, Amazon.com, Inc. announced National Landing (a collection of the Crystal City, Potomac Yard, and Pentagon City neighborhoods) as the location for the expansion of its corporate headquarters. The company is expected to invest in approximately 25,000 jobs, occupying 4 million to 8 million square feet of office space over the next twenty years. The Amazon headquarters expansion is assumed to be part of the generically planned employment growth in the Crystal City Sector plan.

The Crystal City Metrorail station has a single entrance, between S. Clark and S. Bell Streets, just north of 18th Street South. The existing entrance includes a single street-to-mezzanine elevator. Several issues are driving the need to consider construction of a second entrance to the station, including:

- Lack of a direct ADA accessible route for the many users who access the station from the east, particularly those with mobility challenges;
- Need for better connections with the bicycle corridor and high-capacity transit modes east of the station (VRE and Metroway); and
- Inadequate internal station capacity to accommodate long-term passenger demand.

Previous phases of analysis have examined the anticipated ridership increase and corresponding impacts to internal station capacity. Current ridership forecasts anticipate as many as 4,000 AM peak period station entries by 2040 (current AM peak entries are approximately 2,100). While there is no platform overcrowding today, internal station pedestrian simulations show significant queuing and crowding to occur during peak periods by 2030 without the construction of a second entrance and additional vertical circulation elements. Crowding and escalator queues are expected to be most severe on the outbound platform. Construction of a second entrance, with related additional mezzanine and vertical circulation capacity, is expected to provide significant passenger access, circulation, and safety improvements.

Study Purpose

Previous study phases considered a range of potential second entrance alternatives concluding with the location at the northwest corner of 18th Street South and Crystal Drive as the recommended alternative. The purpose of the current analysis is to evaluate the feasibility of the refined Second Entrance Alternative for Crystal City Metrorail station. This report presents the basic rationale, assumptions, criteria, logic, considerations, and level of engineering analysis completed to demonstrate the engineering feasibility of the Second Entrance design elements. This document also identifies the potential risks to station operations and mitigating constructability approaches for the proposed design.

Crystal City Second Entrance Location Map



Design Refinements

The previous conceptual design alternative has been refined to achieve a feasible project while addressing concerns about risks and constructability. Specifically, the refined design addresses the following engineering challenges:

- Reduction of the physical construction constraints within the train room;
- Penetration of the station vault structure;
- Continuation of station operations; and
- Understanding the relationships between and impacts of the proposed station elements with existing and proposed adjacent structures.

The study team coordinated with Arlington County, internal Metro engineers and architects in relevant technical disciplines, and the third party private developer to address specific engineering challenges and design issues. Technical disciplines included Metro staff from Offices of Engineering and Architecture, ADA Policy and Planning, and the Fire Marshal. WMATA has approved the refined design concept plan for advancement to preliminary engineering.

Refined Conceptual Design

The refined second entrance concept includes an entrance stair within the sidewalk space and two ADA compliant elevators located within the façade of a two-story building at the northwest corner of Crystal Drive and 18th Street South. The entrance opens to an underground mezzanine space adjacent to the existing station train room structure. The space will include the faregate array, fare vending, station manager kiosk, required mechanical rooms, restrooms, and an employee breakroom. The connection from the new mezzanine to the existing train room will require repurposing and reconfiguring the existing east mechanical service room to create a new passageway. The passageway will open into the train room on a supported mezzanine structure above the tracks with stairs leading to the inbound and outbound side platforms. The outbound platform will include two mezzanine-to-platform ADA compliant elevators. Due to space constraints, the inbound platform will only include one platform-to-mezzanine ADA compliant elevator.

New Mezzanine and Shell Structure

To reduce the risks associated with construction within the train room, the concept design was refined to minimize the length of the new mezzanine structure inside the station vault and relocate the fare gates and station manager kiosk into the area outside of the existing station footprint. This involved coordination with the proposed development on the south side of the station (above the proposed underground mezzanine), including the placement and orientation of the street-to-mezzanine elevators, entrance stairs, and adjacent building foundation elements. This design refinement increases the area needing to be excavated from the adjacent area outside of the station.

Vault Penetrations and Inbound Platform Elevator Locations

To reduce the risks associated with penetrating the vault structure, the mezzanine-to-platform elevator pairs were refined to minimize the size of the openings to be cut into the vault wall. For the outbound platform elevators, the elevator pair was re-oriented by 90 degrees to reduce the width of the vault penetrations to the width of one rib coffer, only on the platform level. For the inbound platform elevators, the design was refined to include a single elevator at the end of platform in the east service room in order to avoid significant structural impacts and conflicts with the existing adjacent parking garage foundation caissons. Significant mechanical challenges still exist with this design option including relocating existing under-platform exhaust (UPE) duct work and rearranging the mechanical equipment in the east service room. This design option also requires an WMATA design waiver since it does not meet the WMATA Standard of providing two elevators.

(This page left intentionally blank)

Crystal City Second Entrance Conceptual Design Drawings

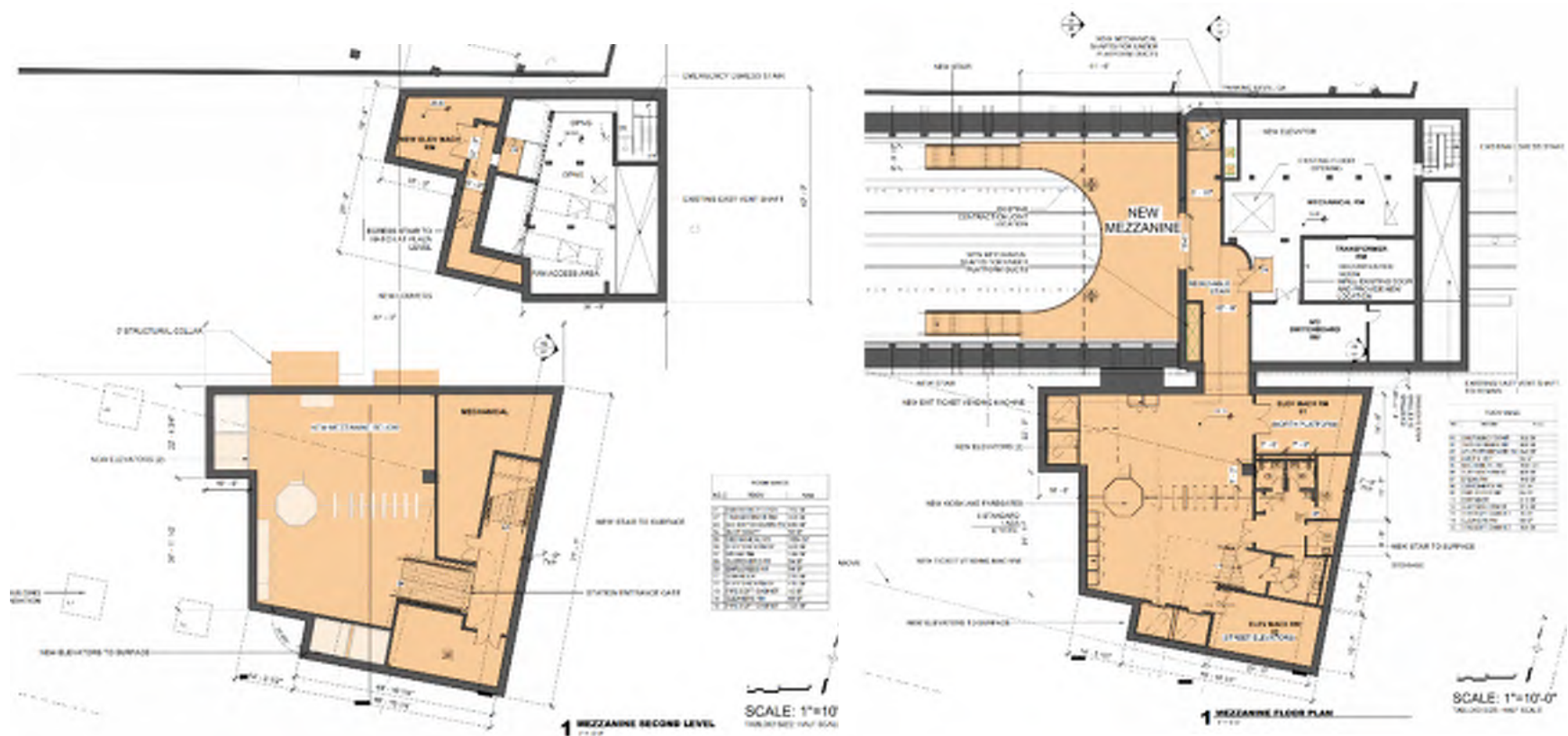

Crystal City Second Entrance Conceptual Design Drawings

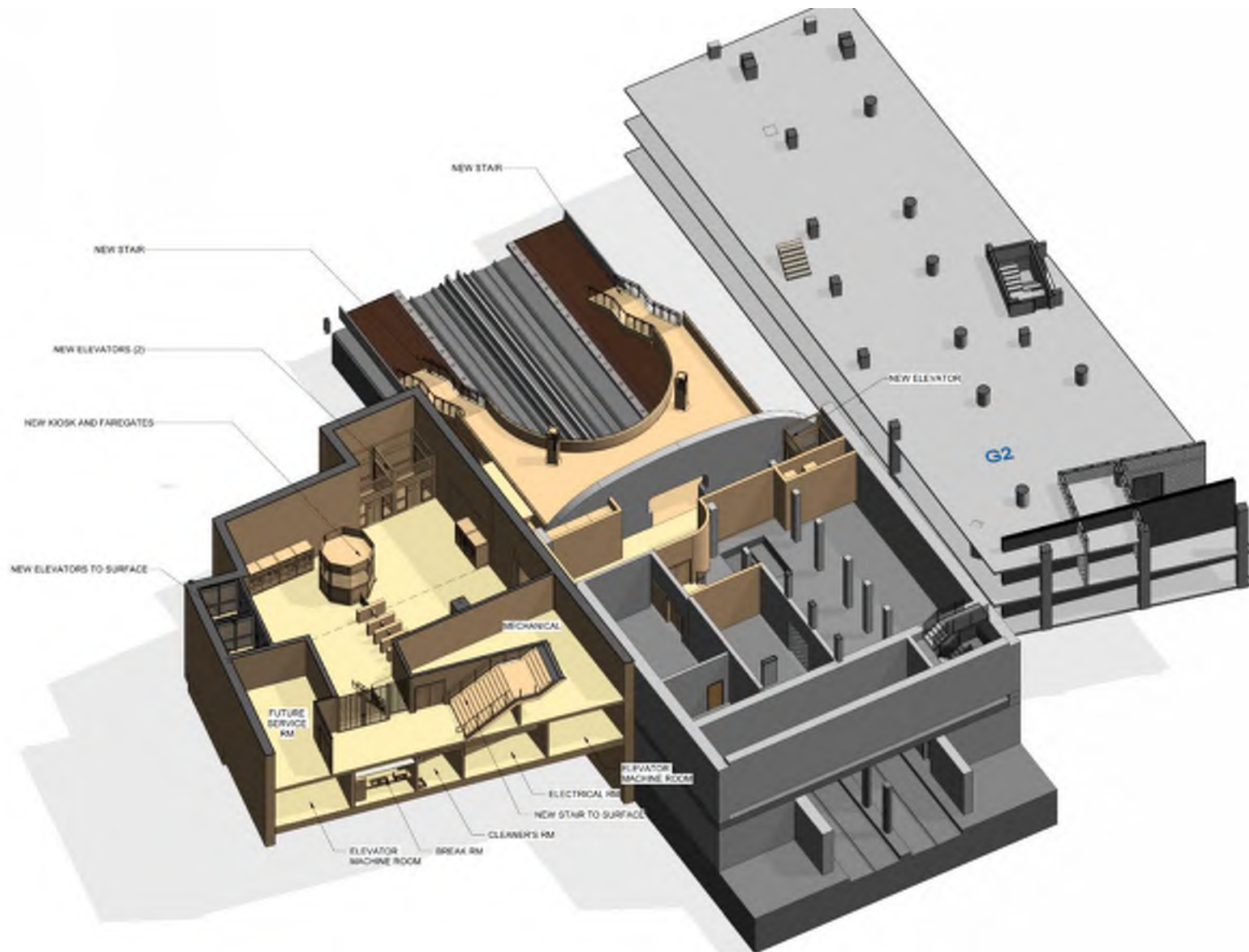

Engineering Feasibility

This assessment includes civil, structural, geotechnical and foundation, mechanical, electrical, communications, and egress considerations of the refined conceptual design. The final conceptual design incorporates adjustments made through the more detailed engineering feasibility analysis. The table below presents a summary of the assessment findings.

Engineering Discipline	Assessment	Considerations for PE
Utilities	Avoids major utility impacts, impacts to 24" stormwater drain line, and traffic signal and street lighting	Further investigation and coordination are required to avoid disruption of service, provide utility relocation, and station tie-in
Geotechnical	Supported on spread footings or mat foundations designed for moderate bearing pressures	<ul style="list-style-type: none"> – SOE systems to provide horizontal stability of existing Metro structures during construction – Dewatering of excavations during construction
Structural	Requires significant demolition and modification to existing station structures to accommodate new platform elevators, passageway, mezzanine decking and columns, and relocated ductwork	<ul style="list-style-type: none"> – Coordination with private developer – Structural collar for vault arch opening – East Service Room openings, end wall and south exterior wall – Mezzanine columns supported by the invert slab
Mechanical Systems	Requires significant modification of existing ductwork and mechanical room layout, and equipment configurations	<ul style="list-style-type: none"> – Re-routing of ductwork and duct shafts to provide adequate clearances – Reconfiguration and consolidation of mechanical equipment in East Service Room and Sewage Ejector Room – New air handling units to accommodate additional cooling loads – Coordination with developer for location of new air-cooled chiller
Electrical Systems	Adequate power capacity appears to be available to accommodate the addition of new elevators, mechanical systems, and other new station functions (lighting, communications, fare vending and payment, etc.)	<ul style="list-style-type: none"> – Verify spare capacity by metering the electrical services – Upgrade AC switchboards and electrical services if necessary – All new normal and emergency lighting fixtures will utilize energy saving LED fixtures
Communications Systems	Requires additional communications equipment including signage, passenger information displays, public announcement system, emergency telephone, and CCTV	<ul style="list-style-type: none"> – Minor relocation of existing communications equipment and conduits – Additional ancillary space created on platform level for communications equipment
Egress Analysis	<p>Additional entrance and platform stairs greatly improve the performance of the existing emergency egress of the station.</p> <ul style="list-style-type: none"> – Meets evacuation timed-egress criteria – Complies with NFPA 130 maximum travel distance of 325 feet to nearest egress point on the platforms – Does not meet the NFPA 130 maximum platform common path travel distance of 82 feet 	All new construction elements, components, systems, and spaces are designed to comply with the requirements of the Virginia Construction Code, except where NFPA 130 criteria apply

Constructability

Overall project constructability is achievable. The table below summarizes the project elements which pose potential risks.

Major Project Elements Driving Schedule, Cost, and Risk

Project Element	Implementation Considerations
Interface Agreement between Metro and the Developer	<ul style="list-style-type: none"> – Address permanent easement for new station entrance related to the overbuild. – Define roles and responsibilities and decision-making for design and construction.
Design	<ul style="list-style-type: none"> – Metro develop Basis of Design to define project blueprint for developer’s designer. Developer’s designer shall adhere to the Basis of Design. Include in interface agreement. – Metro should define the Design QC program and provide Design quality oversight. Include in interface agreement. – Clear scope requirements for design should be determined early in the project between Metro and the developer.
Support of Excavation (SOE)	<ul style="list-style-type: none"> – Regarding the existing Metro structure: Metro shall identify what can/cannot be done, particularly related to waterproofing of the tunnel.
Metrorail Service	<ul style="list-style-type: none"> – Maintaining Metrorail service will limit construction access to the platform and mezzanine areas to nights/weekends.
Metro Systems	<ul style="list-style-type: none"> – Mechanical/Electrical (ME) phasing plan is required before construction can begin. It should protect critical Metro systems, ensure protection from stray current, and integrate existing and permanent ME systems. – Modifications required to support construction activities, e.g. tie-ins to utility feeds. – Complete fit-out will change existing systems and add major equipment, including elevators, new air chiller, escalators, communications, Fire Life Safety, information systems, and power supply.

Sequence of Construction

The table below summarizes the high-level sequence of construction elements, highlighting the critical items that factor into the construction schedule.

Overview of Construction Sequence

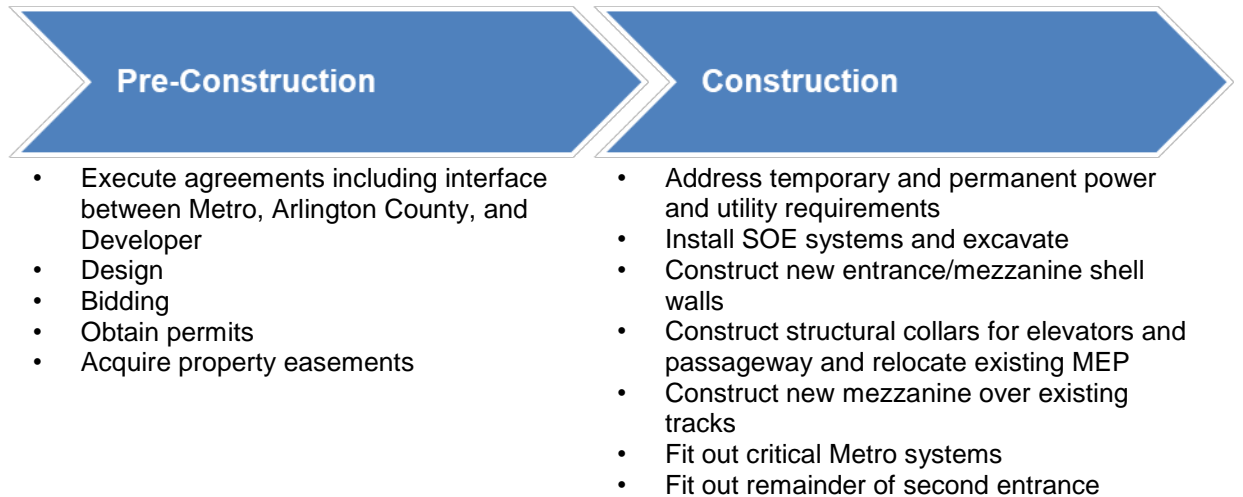

- Prior to construction, the contractor must obtain property access rights including easements, (surface or sub-surface) for construction, and operation, and obtain permits and execute other agreements, including the MOT plan.
- The contractor will prepare for the construction of the new entrance shell and new elevator machine room, including SOE.
- After excavation has been completed, the contractor will install foundations for the walls and elevator pits. The collars will then be cast up against the shell, the walls built, and the roof placed. The roof will have a hole that will provide temporary underground construction access for work within the existing Metrorail tunnel.
- During non-revenue hours, the contractor will cut through the braced station vault where the new mezzanine-to-platform elevator will be located. Concurrently, the contractor will relocate ME systems in the service rooms. Selective wall demolition will connect the existing service area to the new mezzanine area.
- The new mezzanine composite steel structure will be built inside the train room. The primary structure and stay-in-place forms will be built during non-revenue hours, while reinforcement and preparation for the concrete pour can occur during operational hours. The concrete will need to be poured during non-revenue hours.
- Vertical circulation elements will need to be established to connect the new mezzanine to the platform and street levels. New mezzanine-to-platform stairs and elevators will be installed during non-revenue hours. Street-to-mezzanine elevators can be installed during operational hours.
- Fit-out of the mezzanine interior furnishings and remaining MEP elements.
- Finally, close the temporary underground construction access, build the final egress stair, backfill roof and above collar ties, install landscaping and at-grade finishes, and commission elevators.

Schedule

A construction schedule was developed based on the preliminary sequence of construction described below. The anticipated construction duration is 24 months. The schedule is based on traditional design-bid-build delivery. The conceptual schedule identifies the critical path activities that may be done concurrently. The table below presents a summary of the conceptual project schedule.

Overview of Construction Schedule

Activity	Duration
Agreements	12 months
Design	12 months
Bidding	4 months
Permits and Easements	12 months
Procurement	12 months
Submittals	4 months
Construction	24 months

The schedule drivers include:

- The **interface agreement between Metro and the developer** needs to address several key aspects and requires timely execution.
- The **design** defines the scope, schedule and cost of the project, and identifies contract package(s) and long-lead items.
- **Support of Excavation (SOE):** Construction of the second entrance requires SOE for the new mezzanine shell as well as the new elevator machine room for the mezzanine-to-westbound platform elevator. Metro should define what can and cannot be done during construction.
- **Structural modifications:** This work includes vault openings, end wall opening, floor slab openings, and mezzanine construction.
- **Mechanical/Electrical (ME) systems:** Equipment will be installed to support critical functions for continuous service, including signals, communications, fire life safety, passenger information systems, traction power supply, and other ME functions that are resident in the station. Also, the ME systems work to support the construction phase needs to be completed before construction activities requiring access to the station platform begin.
- **Rail operations:** Rail operations will need to be closely coordinated with construction activities. Mezzanine construction will affect passenger access to the east end of the platform; this analysis assumes limiting construction to non-revenue hours and selected weekends.

1 Introduction

The Crystal City Second Entrance design approach and configuration is based on the previously recommended location at the northwest corner of 18th Street South and Crystal Drive (see **Appendix A**). WMATA refined that alternative and the recommended concept design plan is presented in Section 3. The purpose of the Basis of Concept Report (BOCR) is to document the reasoning and decisions made for the refinement and analysis of the preferred Second Entrance Alternative for the Crystal City Metrorail station. The narrative presents the basic rationale, assumptions, criteria, logic, considerations, and level of engineering analysis completed to prove the engineering feasibility of the Second Entrance design elements. This document also identifies the potential risks to station operations and mitigating constructability approach for the proposed design.

1.1 Study Purpose and Overview

The purpose of this study is to evaluate the feasibility of and prepare conceptual design documents for a new east entrance and mezzanine at Crystal City Metrorail Station in Arlington County, Virginia. The previous conceptual design alternative has been refined to achieve a feasible project while addressing concerns about risks and constructability. Specifically, the refined design addresses challenges associated with physical construction constraints within the train room and penetrating the station vault structure while providing for the continued operations of the station. Additionally, on-going coordination with a third party developer, JBG|Smith, was required to understand the relationships between and impacts of the proposed station elements with existing and proposed adjacent structures.

1.2 Background

The Crystal City Metrorail Station is surrounded by high-density residential buildings, office buildings, and retail development. Ronald Reagan Washington National Airport (DCA) is located east of Crystal City, the Pentagon lies immediately to the north, Pentagon City is to the west, and Potomac Yard is to the south.

Previous phases of this study identified that the following issues continue to drive the need to consider construction of a second entrance, including:

- Lack of a direct route for many users from the east, particularly those with mobility challenges, to the station entrance;
- Need for better connections with other modes – Virginia Railway Express (VRE), buses, bicycles, etc.; and
- Inadequate station capacity to accommodate long-term passenger demand.

Previous study phases considered four potential alternatives, two on the west side of Crystal Drive and two on the east side of Crystal Drive. Upon further review of the east side alternatives, they were eliminated from consideration due to adjacent property impacts and utility impacts. The northwest corner of 18th Street South and Crystal Drive was concluded to be the recommended alternative to be further developed (see **Figure 1**).

1.2.1 Multimodal Hub

Crystal City has become an important multimodal hub in the region; transit options include Metrorail, commuter bus and rail, and bus only lanes with transit stations. Crystal City is served by VRE – a commuter rail service that connects the Northern Virginia suburbs to Union Station in Washington, DC. Crystal City VRE Station is located approximately 1,100 feet from the Metrorail station entrance.

According to the VRE Strategic Plan¹, Crystal City is the destination of 8.8 percent of total VRE riders. VRE reported 4.8 million annual trips in the fiscal year ended June 30, 2012, so an estimated 212,200 VRE trips terminated in Crystal City in 2011-2012, up 36 percent from 2005. The Strategic Plan anticipates up to 968 additional alightings at Crystal City by the Plan's horizon year of 2025. This will represent a total of approximately 2,025 VRE riders per day alighting at Crystal City VRE Station in 2050, representing growth of about 160 percent. VRE is currently studying potential improvements to Crystal City VRE Station to improve capacity and operations.

In addition, Metro operates Metroway, the region's first premium bus service in bus-only lanes, connecting Crystal City with adjacent neighborhoods at Potomac Yard and Pentagon City. This premium transit service greatly enhances connections between the neighborhoods and access to the Metrorail system. The bus stop at 18th Street South and Crystal Drive will be the critical and convenient transfer location between Metroway and the Metrorail system at Crystal City station.

1.2.2 Future Station Entries

The Crystal City Sector Plan (2010) indicates that the total floor area in the vicinity of the station will grow by approximately 61 percent by 2050, nearly all of it within easy walking distance of Crystal City Metrorail Station. The Crystal City Sector Plan at build-out (2050) will include 57,400 workers with 15.9 million square feet of office inventory. As proposed development and redevelopment occurs, increasing the percentage of residential and retail uses, ridership peaks will grow considerably but also be somewhat flattened. In other words, the station will be generally busier overall and busy during a longer period of the day with broader spikes extending into late morning and evening periods.

Previous phases of the study examined the anticipated ridership increase and corresponding impacts to internal station capacity (see **Appendix B**). Current ridership forecasts anticipate as many as 4,000 AM peak period station entries by 2040 (current AM peak entries are approximately 2,100). While there is no platform overcrowding today, internal station pedestrian simulations conducted in 2013 showed that significant queuing and crowding would occur during peak periods by 2030 without the construction of a second entrance and additional vertical circulation elements, particularly on the outbound platform. Projected future No-Build (2030) conditions showed that during the peak 15 minutes (8:15 – 8:30 AM) of the AM Peak

¹ Virginia Railway Express Strategic Plan 2004-2025, May 2004.
http://www.vre.org/about/strategic/strategic_plan.htm

Hour, passengers would experience overcrowded conditions of LOS E (5-10 sf/pax) or F (< 5sf/pax) across 55 percent of the outbound (south) platform area.

Overall Metrorail boardings have declined in recent years. To better understand the ridership trends Metro developed the 2018 Integrated Metrorail Ridership Forecast which provides an upper bound and lower bound forecast for each Metrorail station through 2040. The 2040 forecast for the Crystal City Metrorail Station in the AM Peak (opening to 9:30 AM) is 3,240 entries for the lower bound and 4,051 entries for the upper bound. The previous forecasts, which served as the basis for pedestrian crowding and safety assessment, are consistent with the refined forecasts. The forecasts and simulations demonstrate the significant extent to which construction of a second entrance provides passenger access, circulation and safety improvements over the No-Build Condition.

Amazon.com, LLC Corporate Headquarters Expansion

In November 2018, Amazon.com, LLC announced National Landing (a collection of the Crystal City, Potomac Yard, and Pentagon City neighborhoods – see **Figure 2**) as the location for the expansion of its corporate headquarters. The company is expected to invest in approximately 25,000 jobs, occupying 4 million to 8 million square feet of office space over the next twenty years. The 2050 ridership forecast accounts for future growth attributed to the full realization of the Crystal City Sector Plan. The Amazon HQ2 is assumed to be part of this generically planned employment growth in the Crystal City Sector plan. Therefore, the ridership projections and internal station egress analysis already consider employment levels that are expected given the recently announced Amazon HQ2 location choice at Crystal City. The Amazon HQ2 announcement does not change the projected future demand at the station.

Figure 2 | Amazon Headquarters at National Landing, Virginia



Source: JBG|Smith; www.nationallanding.com

1.2.3 Developer Coordination

Since the completion of the previous study in February 2016, JBG|Smith (“the developer”) commenced with plans to redevelop the superblock bound by Crystal Drive, 18th Street South, South Bell Street, and 15th Street South. The plans include a new two-story retail building and plaza at the approximate location of the recommended station entrance portal (see **Figure 3**).

In collaboration with the developer, Metro and Arlington County have refined the previously-developed conceptual design to coordinate with the developer’s plans while also conforming to Metro design criteria and adjacent construction standards. An entrance to the Metrorail system fronting Crystal Drive is strategically and mutually beneficial for Metro, Arlington County, and the developer in achieving the goals of the Crystal City Sector Plan.

In the current phase of this project, the refined alternative has been evaluated to the level of technical detail needed to prove engineering feasibility and prepare for the next phase of preliminary and final engineering, and construction. The following narrative presents the design decisions and engineering analysis completed to achieve the refined conceptual design.

Figure 3 | JBG|Smith Central District Redevelopment (Rendering)



Source: JBG|Smith

2 Design Refinements and Initial Engineering Assessment

This section provides a summary of the major design refinements and considerations for the conceptual design for the second entrance of Crystal City Metrorail Station. The approach to design refinements was an iterative process; the study team worked through various engineering challenges as the design progressed (see **Figure 4**).

The study team started with the recommended alternative located at the corner of 18th Street South and Crystal Drive developed as part of the 2015 study. In coordination with the developer, the concept design was refined to better integrate into the proposed development and to work out architectural and engineering details of various design options. Additionally, the study team coordinated with Arlington County and internal Metro engineers and architects in relevant technical disciplines to address specific engineering challenges and design issues. Technical disciplines included Metro staff from Offices of Engineering and Architecture, ADA Policy and Planning, and the Fire Marshal.

Figure 4 | Design Refinement Process

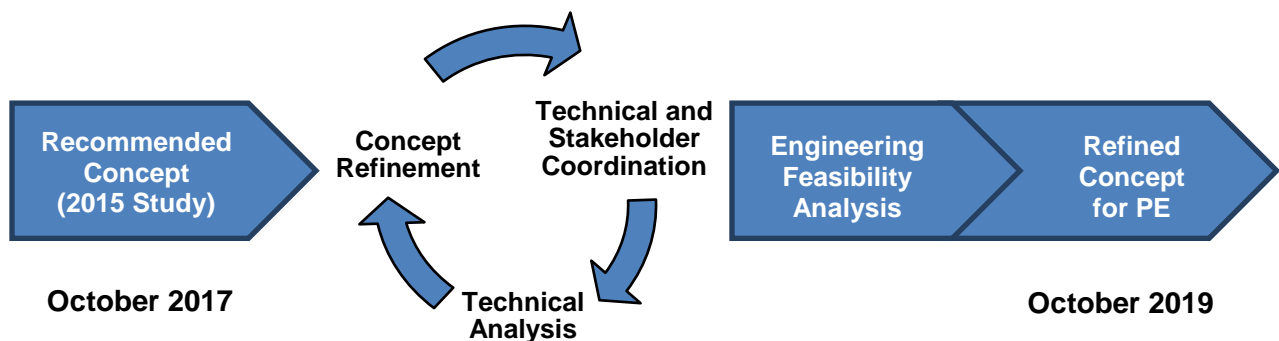

2.1 Design Refinements

As a way of achieving a feasible project while addressing concerns about risks and constructability, the following considerations for refinement were analyzed:

- Reduce the risks associated with construction within the train room and penetrating the vault structure for mezzanine-to-platform elevators;
- Provide for the continued operations of the station, including providing adequate space for and re-orientation of the mechanical functions and equipment, and service and elevator machine rooms; and
- Coordination with the developer to understand the relationships between and impacts of the proposed station elements with the proposed building and adjacent structures, including entrance portal (stairs, no escalator), street-to-mezzanine and mezzanine-to-platform elevators, underground mezzanine foundations, and vent shaft location.

The following narrative presents the engineering analysis and decision-making process for the design refinements. The narrative was developed before Amazon.com, LLC decided to locate its second headquarters in Crystal City and may be refined as coordination with Arlington County, the developer, and Amazon.com, LLC advances.

2.1.1 New Mezzanine and Shell Structure

To reduce the risks associated with construction within the train room, the concept design was refined to minimize the length of the new mezzanine structure inside the station vault and relocate the fare gates and station manager kiosk into the area outside of the existing station footprint. This involved coordination with the proposed development on the south side of the station (above the proposed underground mezzanine), including the placement and orientation of the street-to-mezzanine elevators, entrance stairs, and adjacent building foundation elements. This design refinement increases the area needing to be excavated from the adjacent area outside of the station.

2.1.2 Vault Penetrations and Inbound Platform Elevator Locations

In addition, to reduce the risks associated with penetrating the vault structure, the mezzanine-to-platform elevator pairs were refined to minimize the size of the openings to be cut into the vault wall. For the outbound platform elevators, the elevator pair was re-oriented by 90 degrees to reduce the width of the vault penetrations to the width of one rib coffer, only on the platform level.

For the inbound platform elevators, however, the engineering complexities involved with penetrating the vault wall to locate the elevators in the garage level of the adjacent structure needed to be examined in greater detail to prove feasibility. Three design alternatives were examined: 1) dual elevators in the adjacent garage, 2) a single elevator in the adjacent garage, and 3) a single elevator at the end of platform in the east service room. The two design alternatives that involved the adjacent garage have significant structural impacts and conflicts with the existing parking garage foundation caissons.

Ultimately, the option to place a single elevator on end of the platform within the east service room was determined to be the most feasible due to eliminating the need to penetrate the vault wall and the need to make any modifications to the existing parking garage adjacent to the station. Significant mechanical challenges still exist with this design option including relocating existing under-platform exhaust (UPE) duct work and rearranging the mechanical equipment in the east service room. The mechanical complexities are addressed in the Engineering Feasibility section (see Section 3).

2.1.3 Vent Shaft Relocation

The developer requested that the existing vent shaft and access stairwell be moved from their current locations to outside the limits of the proposed plaza in front of 1770 Crystal Drive. Metro has indicated that they will have to convert the existing vent shaft into a fan shaft at some future point per an FTA requirement. The study team evaluated the feasibility of relocating the vent shaft and access stairwell. The access stairwell can be removed and replaced with a hatch because it will not be used for maintenance access in the future, just for emergency egress. The relocation of the vent shaft would have significant structural impacts due to the placement of the

existing roof support structure and column locations (see **Figure 5**). The orientation of the new vent shaft opening would be skewed from the direction of the one-way concrete slabs. The length of the new vent shaft would require that the existing concrete beams supporting the roof slab to be cut, which eliminates their load-carrying capacity. Due to the large area of the existing roof support structure needing to be removed for new vent shaft opening, the entire roof in this area would need to be demolished and a new roof slab cast to accommodate the new vent shaft opening. The new roof framing would need to be tied into the existing column locations so the loads can be distributed down to the foundation slab.

Figure 5 | Partial Plan of Existing Roof Framing

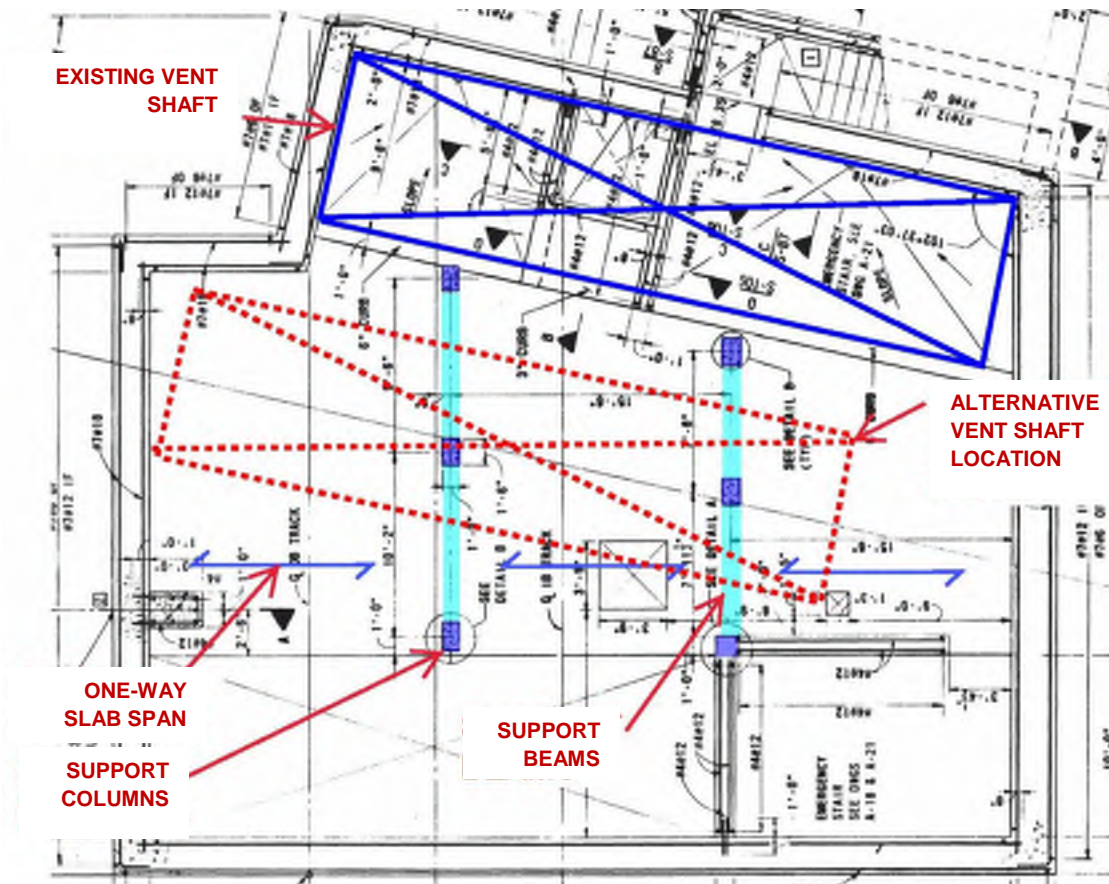

Source: Metro record drawings, sheet C8a-S-138.

For the purpose of this engineering feasibility assessment, it is recommended to relocate the access to the stairwell only and keep the vent shaft at the current location. The refined concept reflects this recommendation and is contingent on this decision. The refinement provides additional square footage above the East Service Rooms under the plaza level for an elevator machine room and wraps the egress stairs around the vent shaft to open through a small hatch at ground level, to not conflict with the landscape designed plaza (see **Figure 6**).

Figure 6 | Relocated Access Stairwell

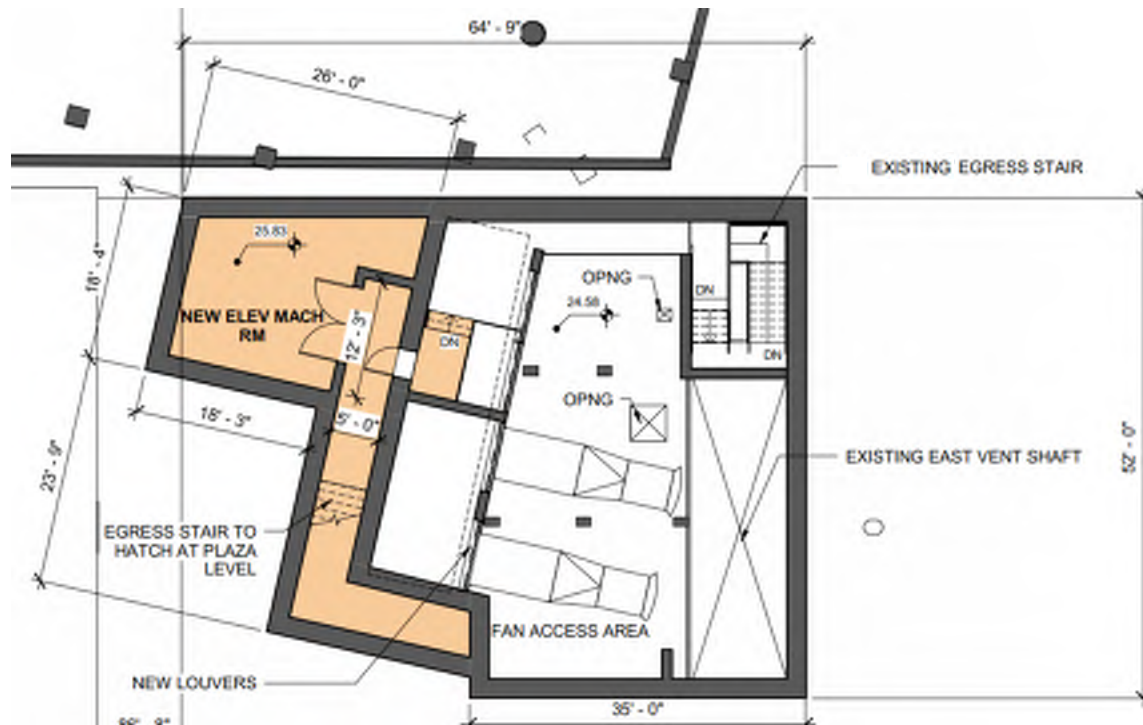

3 Refined Second Entrance Conceptual Design

The following pages show the refined design concept for the Second Entrance to Crystal City Metro station. This design incorporates the initial design refinements as well as adjustments made through the more detailed engineering feasibility analysis.

The refined second entrance concept includes an entrance stair within the sidewalk space and two ADA compliant elevators located within the façade of a two-story building at the northwest corner of Crystal Drive and 18th Street South. The entrance opens to an underground mezzanine space adjacent to the existing station train room structure. The space will include the faregate array, fare vending, station manager kiosk, required mechanical rooms, restrooms, and an employee breakroom. The connection from the new mezzanine to the existing train room will require repurposing and reconfiguring the existing east mechanical service room to create a new passageway. The passageway will open into the train room on a supported mezzanine structure above the tracks with stairs leading to the inbound and outbound side platforms. The outbound platform will include two mezzanine-to-platform ADA compliant elevators. Due to space constraints, the inbound platform will only include one platform-to-mezzanine ADA compliant elevator.

(This page left intentionally blank)

Figure 7 | Refined Concept Plan: Vicinity Plan



Figure 8 | Refined Concept Design Plan: Demolition Plans

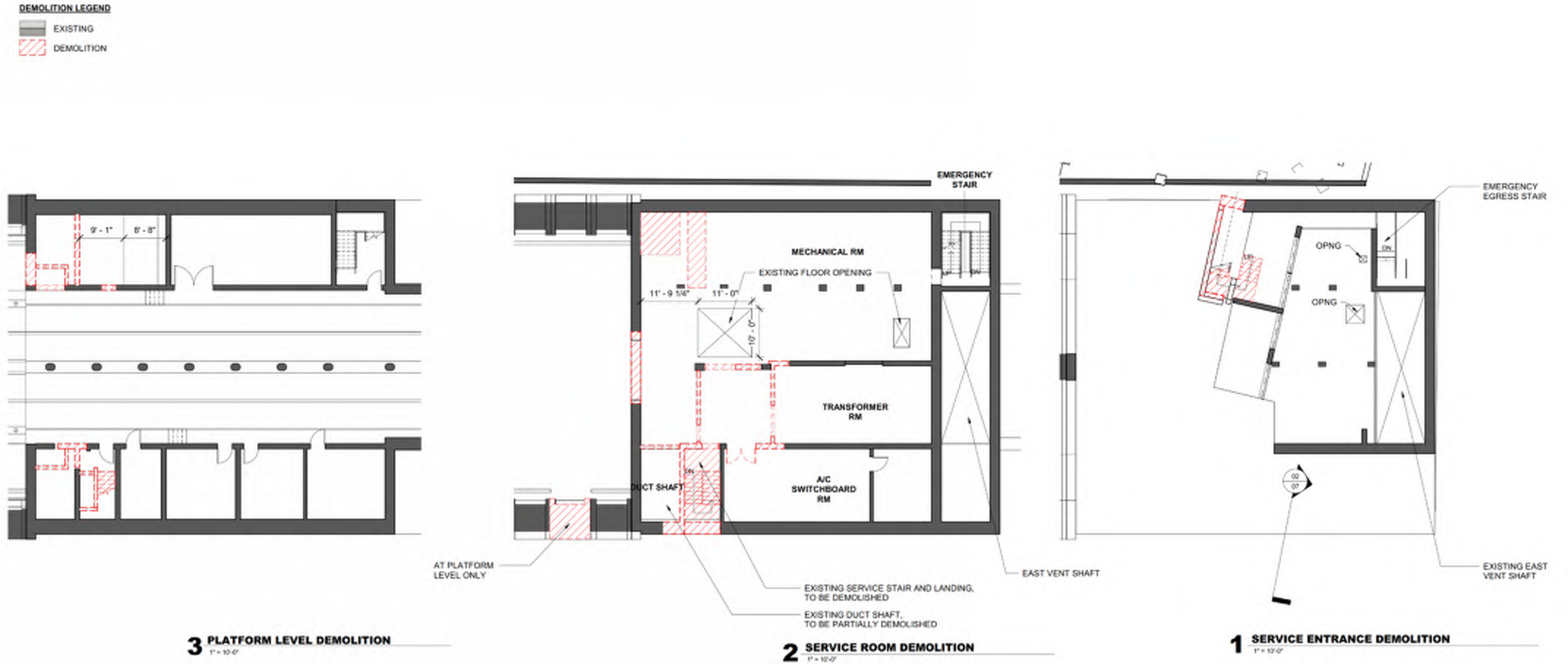

Figure 9 | Refined Concept Design Plan: Street Level

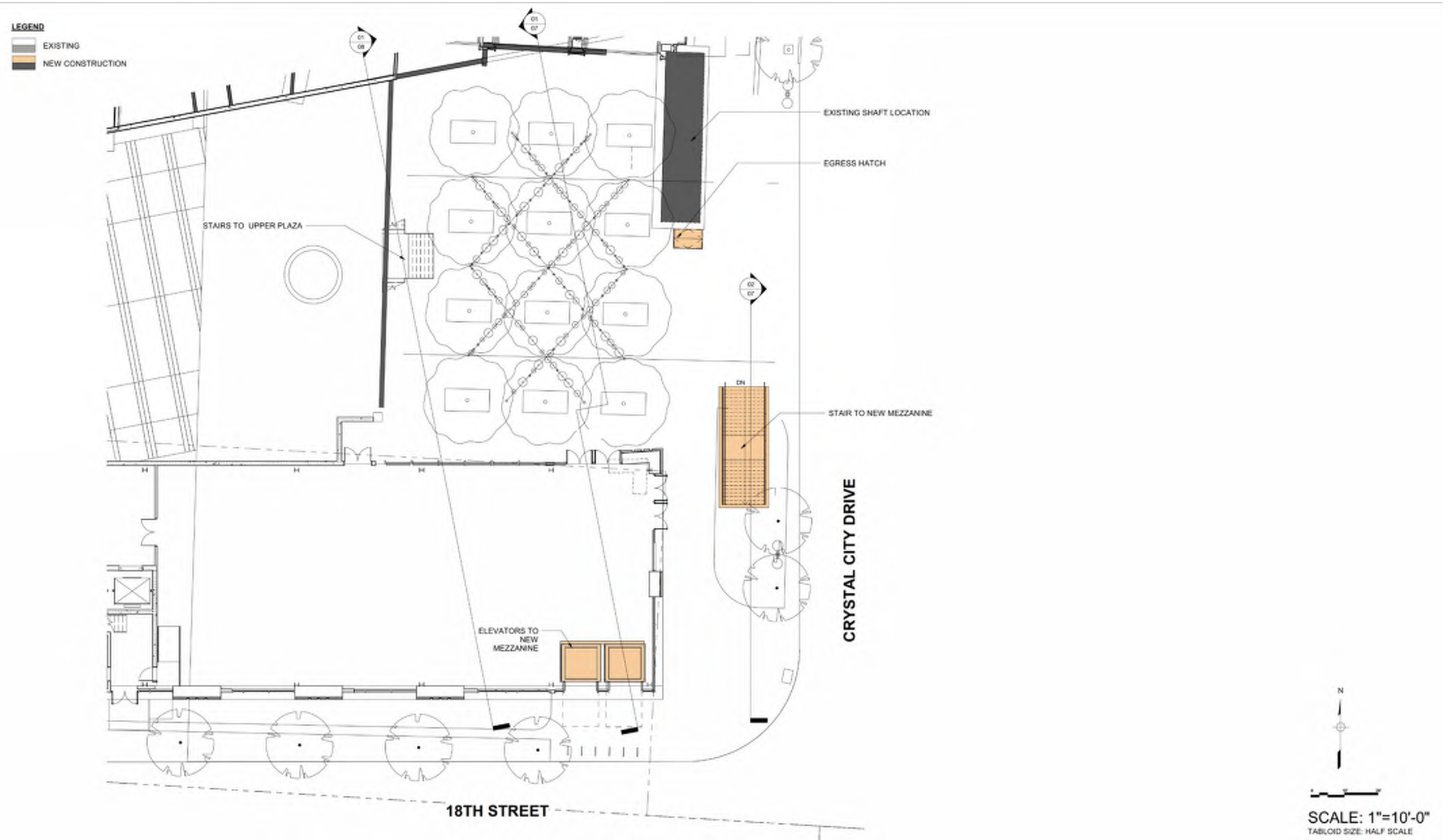
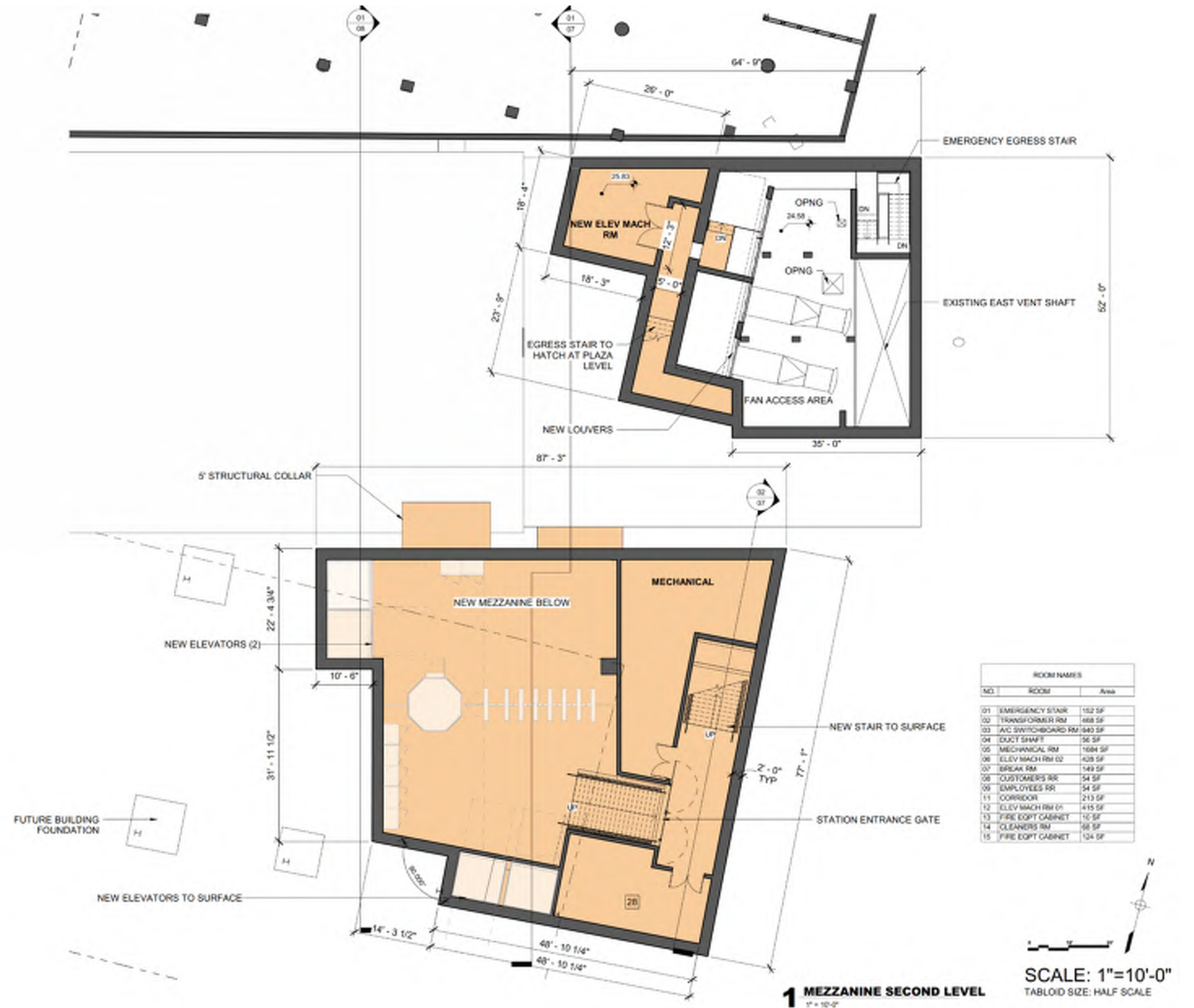

Figure 10 | Refined Concept Design Plan: Mezzanine Second Level

LEGEND
 [Grey Box] EXISTING
 [Orange Box] NEW CONSTRUCTION



DURING PRELIMINARY ENGINEERING DETERMINE THICKNESS OF NEW WALLS AND COLLARS

Figure 11 | Refined Concept Design Plan: New Mezzanine Floor Plan

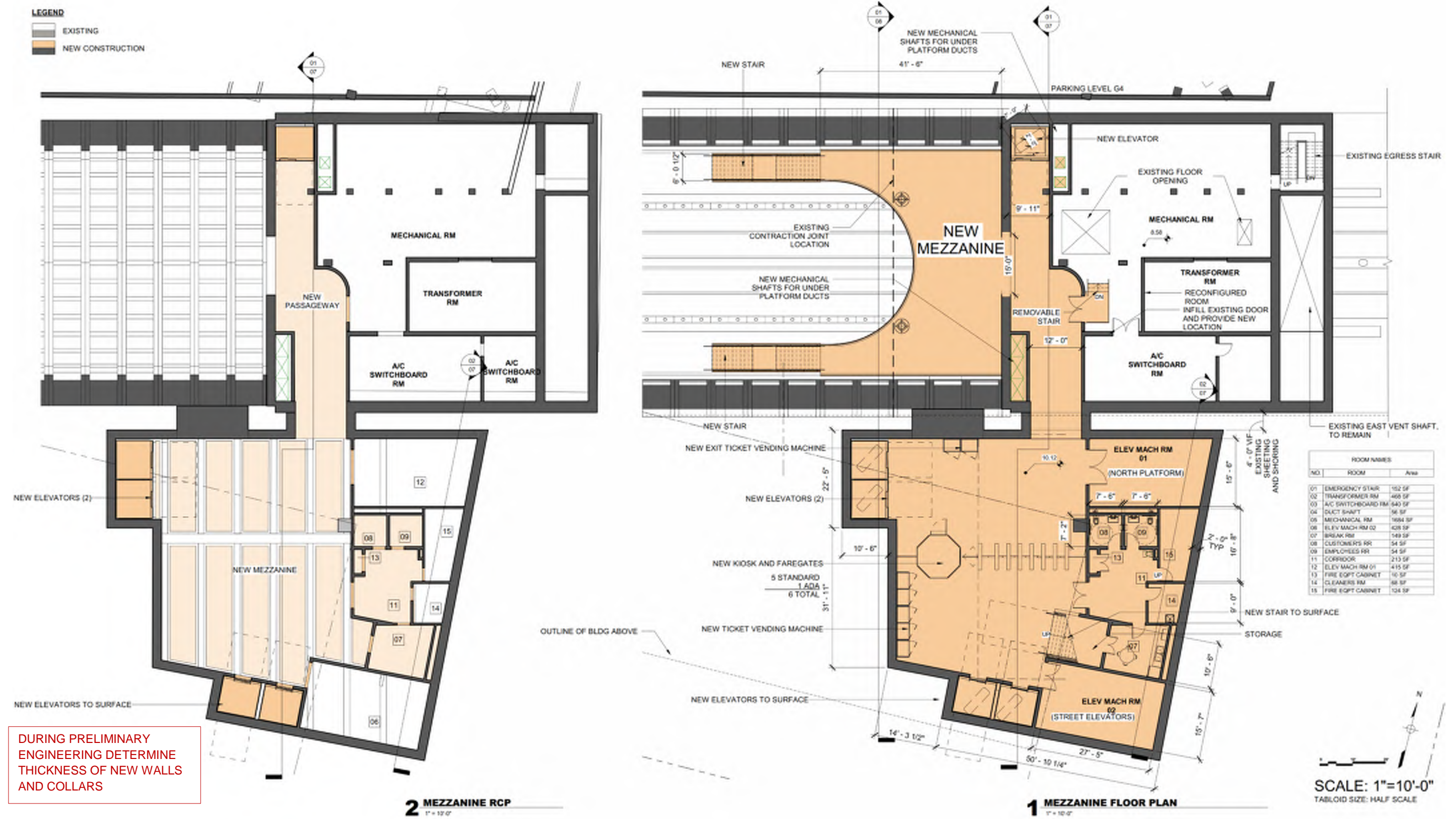

Figure 12 | Refined Concept Design Plan: Platform Level Floor Plan

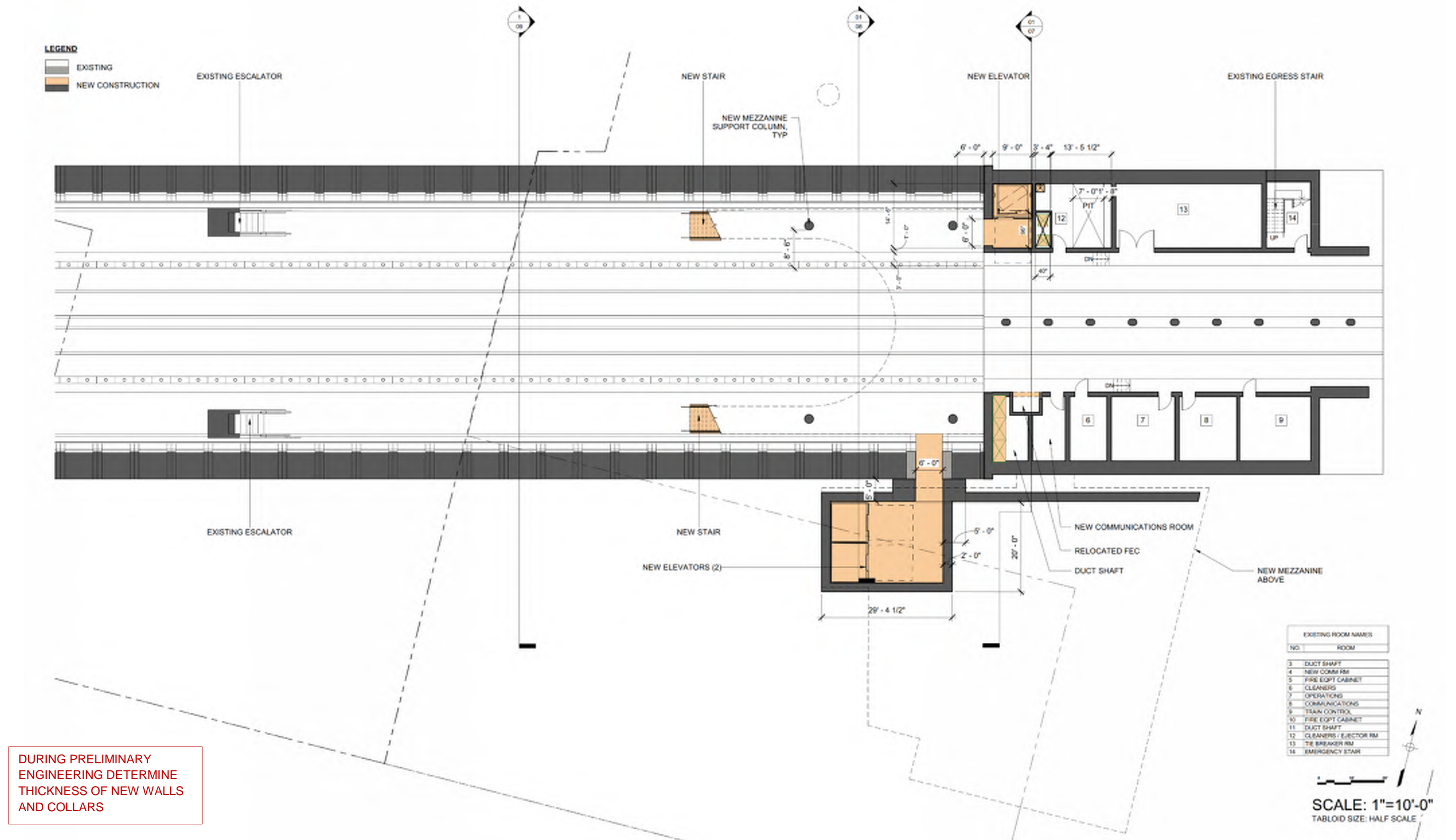
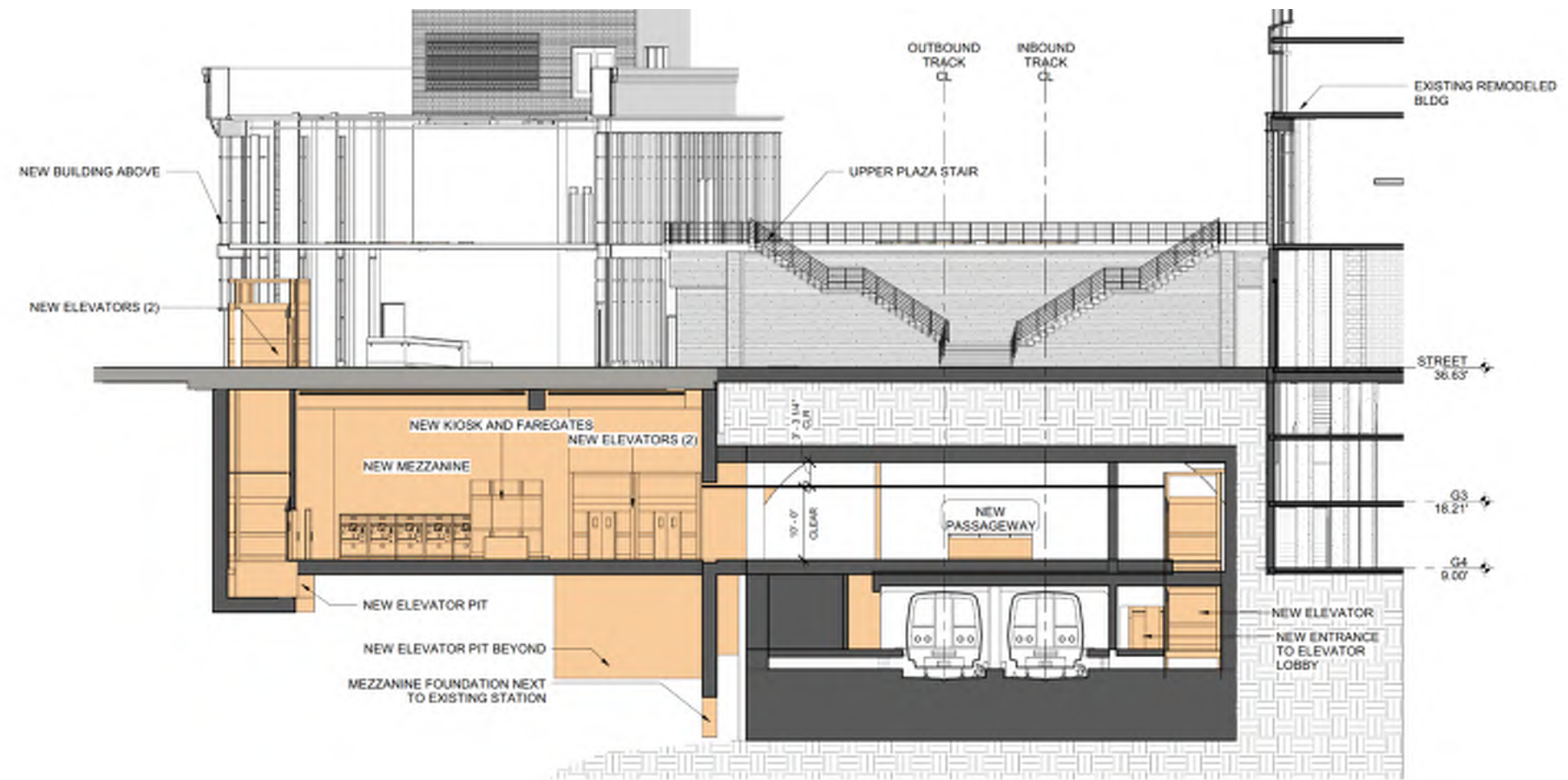

Figure 13 | Refined Concept Design Plan: Mezzanine and Building Sections

LEGEND
 [Grey Box] EXISTING
 [Orange Box] NEW CONSTRUCTION



01 SECTION THRU NEW MEZZANINE
 1" = 10'-0"

ROOM NAMES		
NO.	ROOM	Area
01	EMERGENCY STAIR	112 SF
02	TRANSFORMER RM	468 SF
03	A/C SWITCHBOARD RM	643 SF
04	DUCT SHAFT	56 SF
05	MECHANICAL RM	1084 SF
06	ELEV MACH RM 02	428 SF
07	SRVAK RM	148 SF
08	CUSTOMERS RR	34 SF
09	EMPLOYEES RR	34 SF
11	CORRIDOR	313 SF
12	ELEV MACH RM 01	415 SF
13	FIRE EQPT CABINET	10 SF
14	CLEANERS RM	66 SF
15	FIRE EQPT CABINET	124 SF

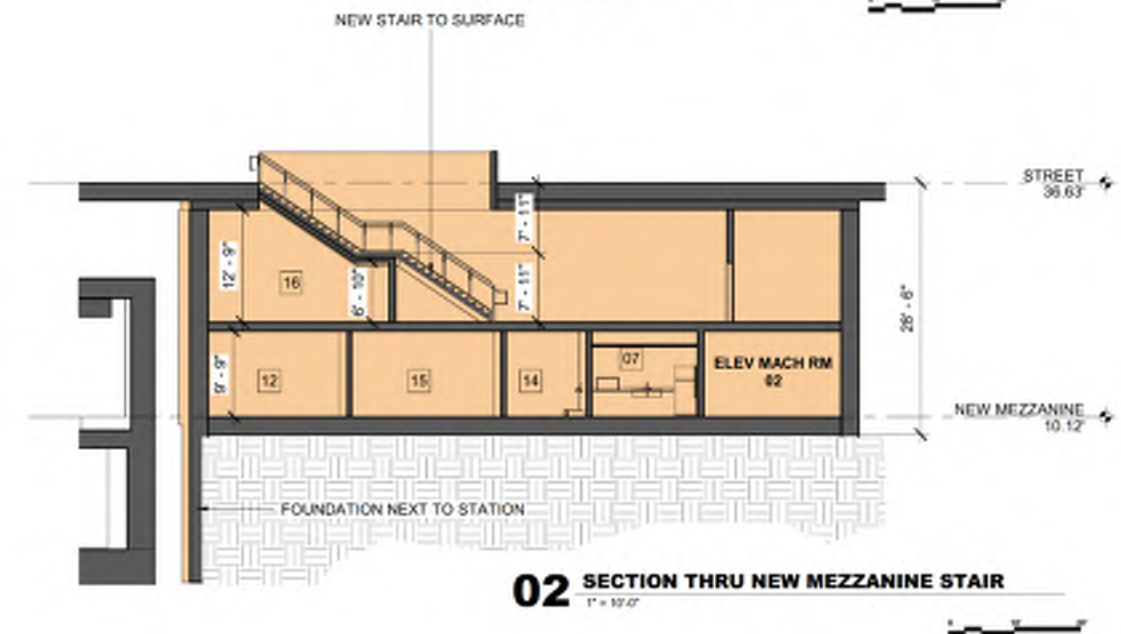

02 SECTION THRU NEW MEZZANINE STAIR
 1" = 10'-0"

DURING PRELIMINARY ENGINEERING DETERMINE:
 THICKNESS OF NEW WALLS AND COLLARS
 TYPE OF NEW FOUNDATION
 SPACE REQUIREMENTS FOR ELEMENTS LOCATED BETWEEN TOP OF THE NEW BOX AND PLAZA (E.G. UTILITY DUCT BANKS)
 MEANS OF SUPPORT FOR THE NEW BUILDING

Figure 14 | Refined Concept Design Plan: Tunnel and Building Section

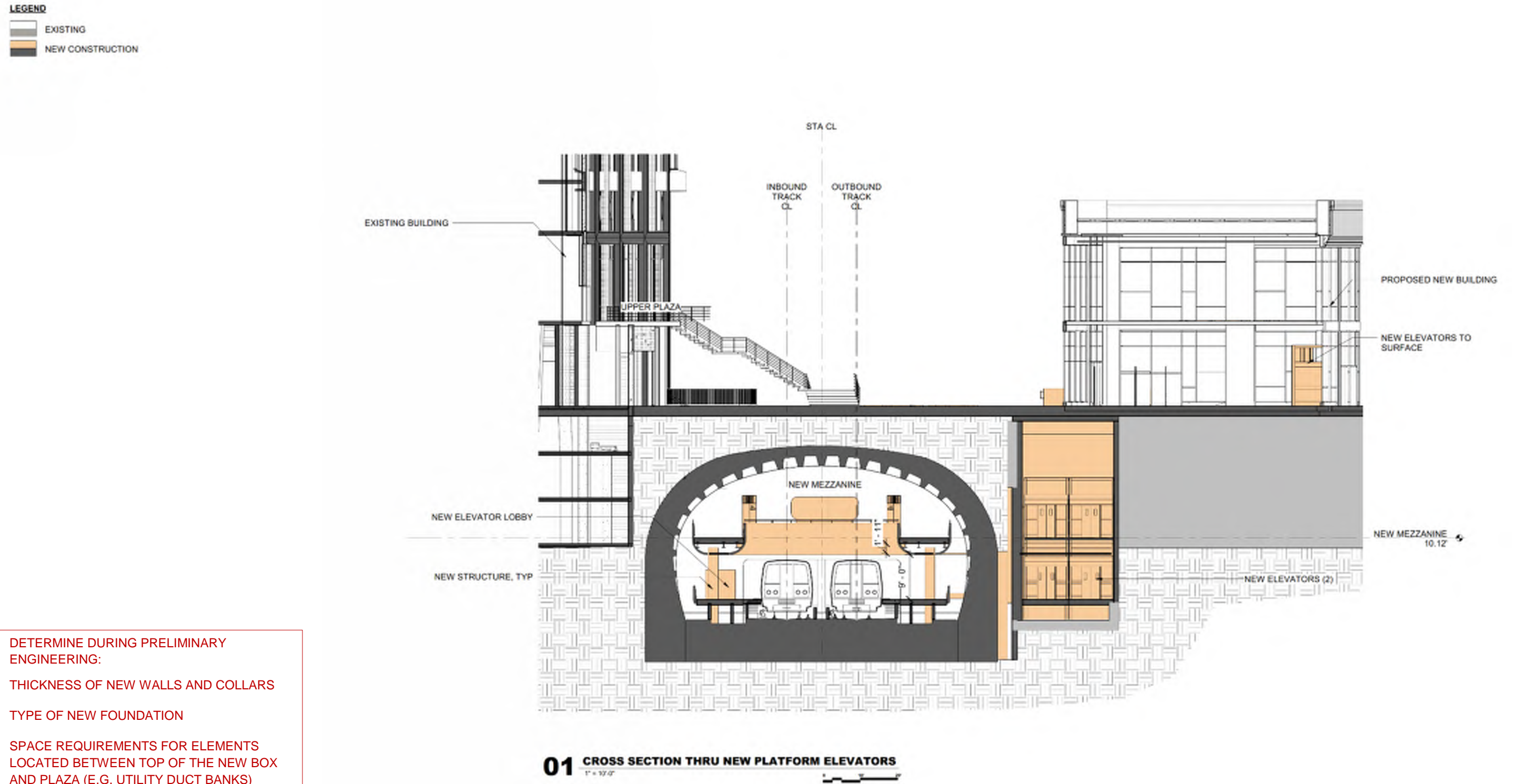

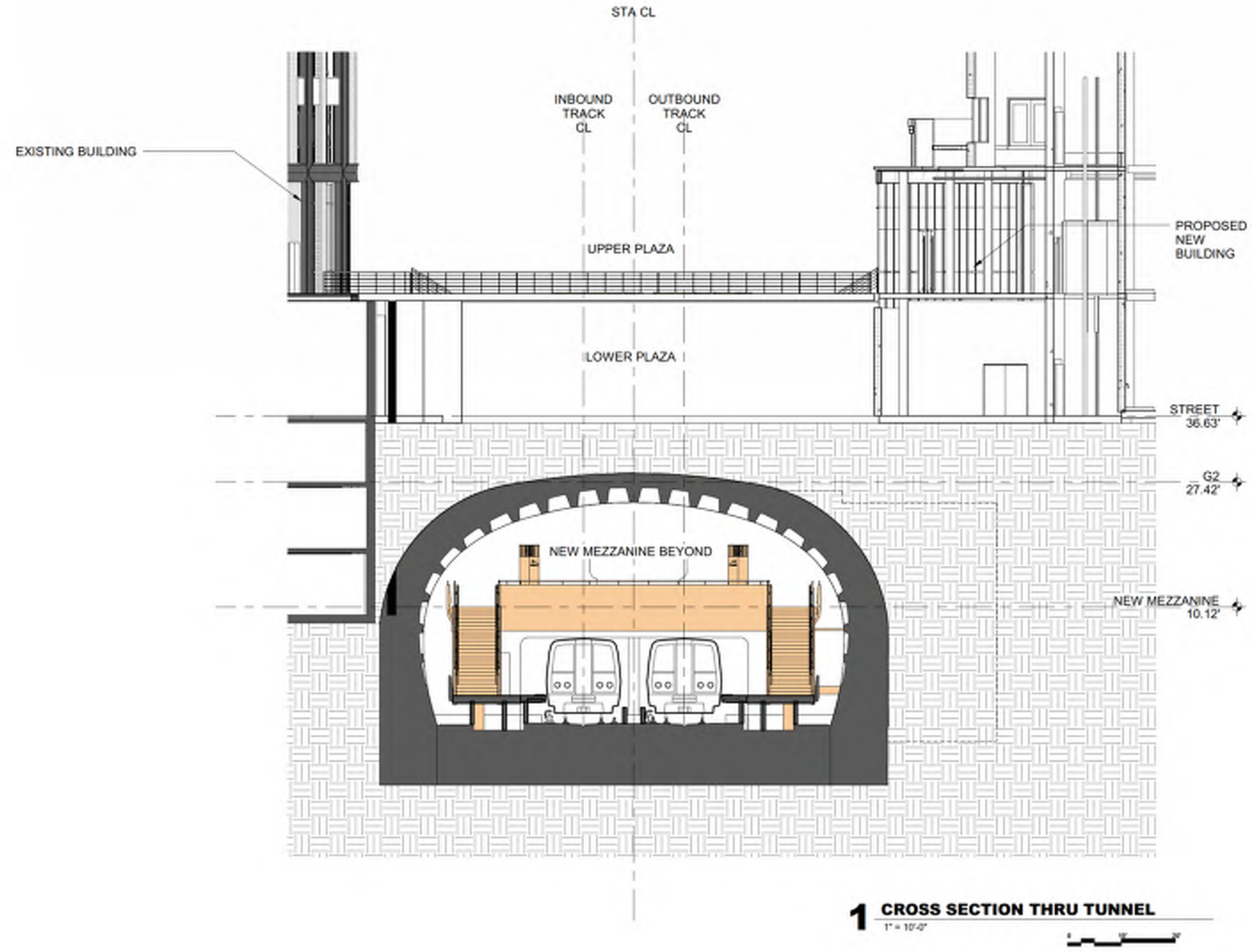

Figure 15 | Refined Concept Design Plan: Cross Section Thru Tunnel

LEGEND

-  EXISTING
-  NEW CONSTRUCTION



DETERMINE DURING PRELIMINARY ENGINEERING:
 TYPE OF NEW FOUNDATION
 SPACE REQUIREMENTS FOR ELEMENTS LOCATED BETWEEN TOP OF THE NEW BOX AND PLAZA (E.G. UTILITY DUCT BANKS)
 MEANS OF SUPPORT FOR THE NEW BUILDING

Figure 16 | Refined Concept Design Plan: Mezzanine 3D View

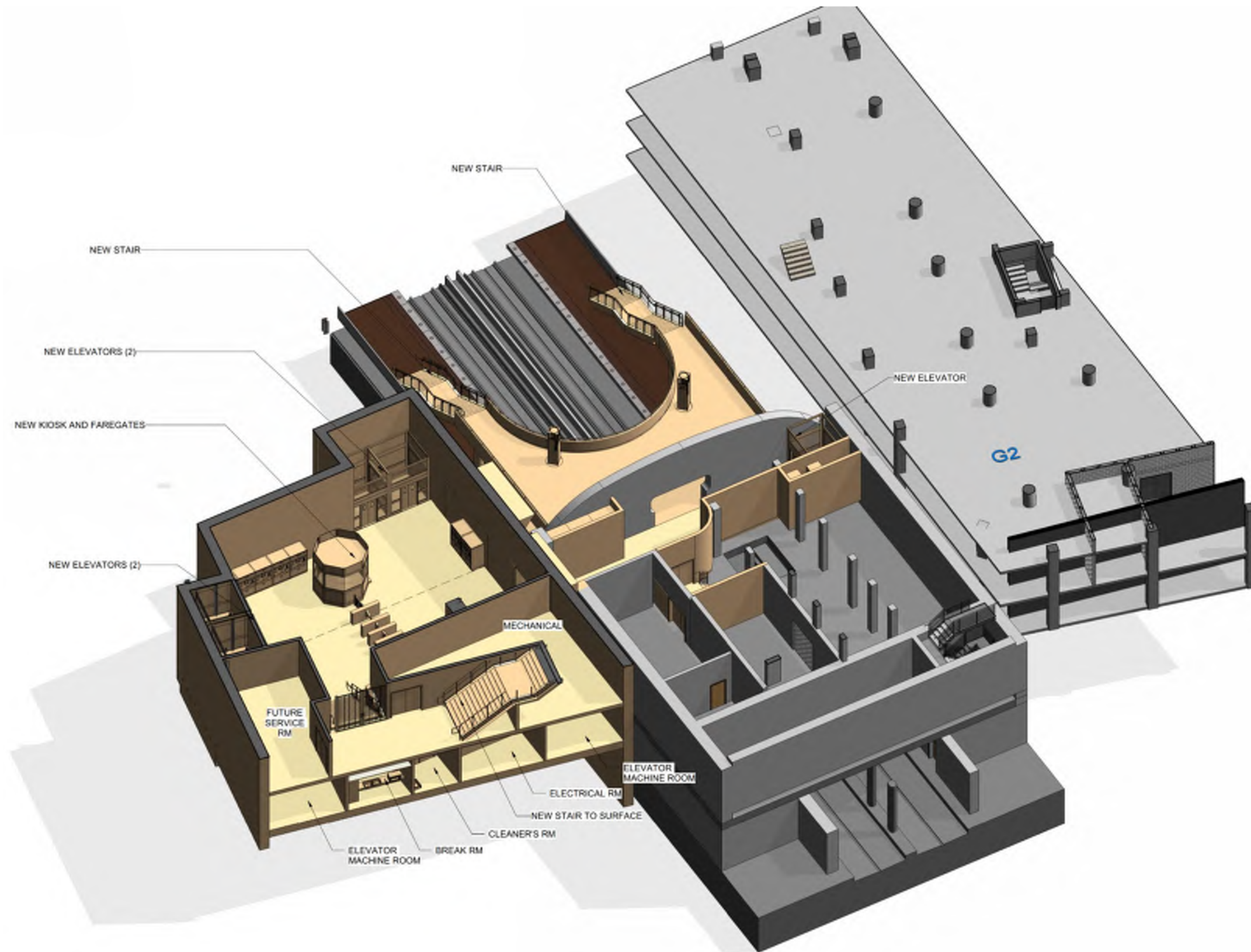
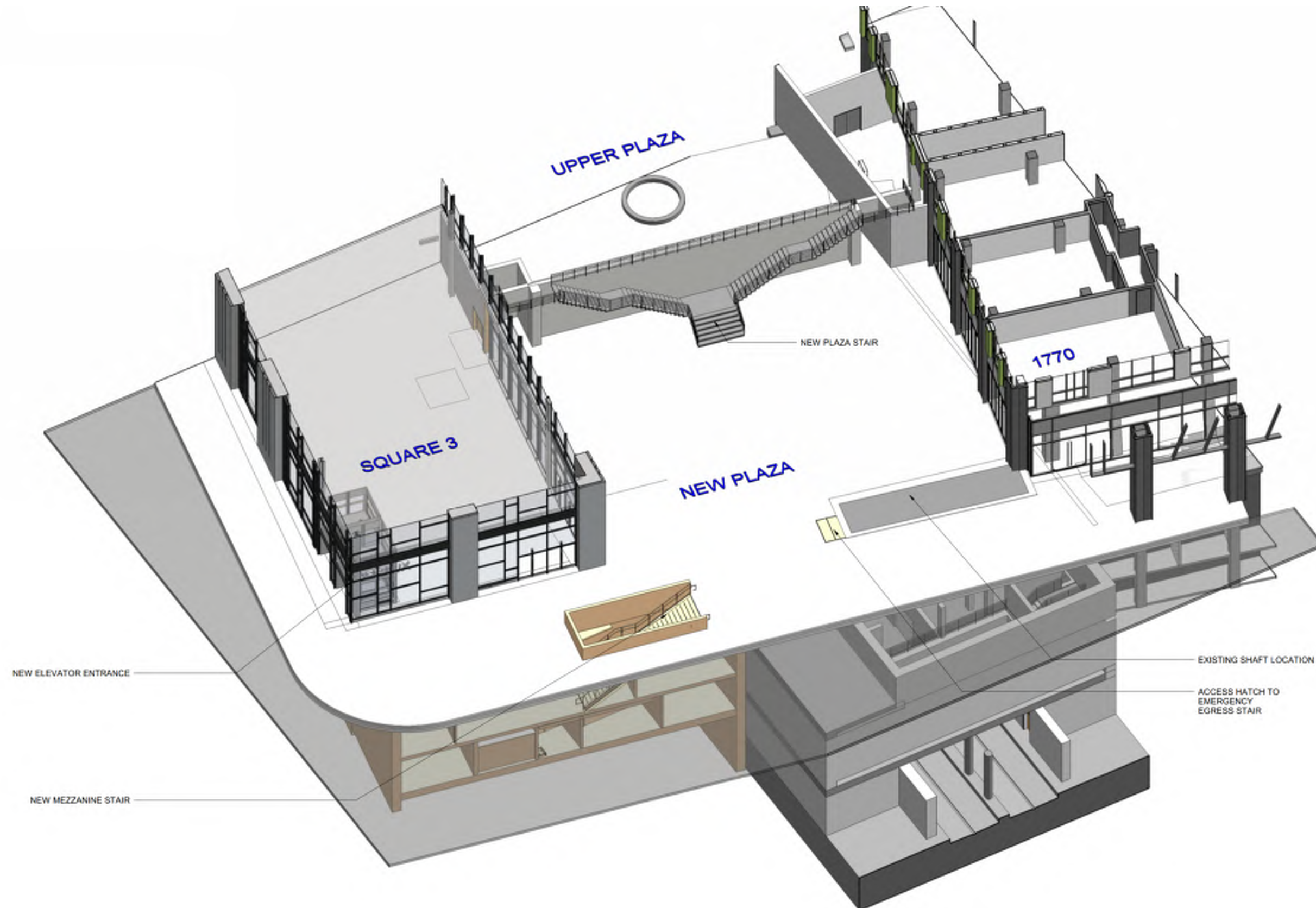

Figure 17 | Refined Concept Design Plan: Site 3D View



(This page left intentionally blank)

4 Engineering Feasibility Assessment of Refined Design Concept

This section provides a more detailed assessment of engineering feasibility and identifies the next steps for construction of the second entrance and east mezzanine at Crystal City Metrorail Station. The second entrance design concept was developed to the level of design needed to demonstrate its feasibility. This assessment includes civil, structural, geotechnical and foundation, mechanical, electrical, and construction phasing considerations of the refined design concept.

4.1 Utilities

An inventory of existing utilities in the project vicinity is listed in **Table 1** and shown in **Figure 18**. Utilities include electric, telephone, gas, sanitary sewer, storm drain, and water. Most of the major utilities are located beneath Crystal Drive and it appears that the second entrance avoids major utility impacts. The concept design will likely impact the 24" stormwater drain line and traffic signal and street lighting located at the northwest corner of 18th Street South and Crystal Drive. Telecommunications facilities are located near the project site and could possibly be impacted during construction. Further investigation and coordination are required to avoid disruption of service and provide the relocation of impacted utilities, as well as potential station tie-in. This coordination will occur between the developer, Arlington County, and utility owners as part of the redevelopment project.

Table 1 | Existing Utilities

Utility Type	Utility Owner	Description
Electric	Dominion Power	Two underground electrical lines are located beneath the Northbound lanes of Crystal Drive.
Sanitary Sewer	Arlington County	15" sanitary line is located beneath the eastern gutter along Crystal Drive.
Natural Gas	Washington Gas	6" gas main is located beneath Northbound lane of Crystal Drive.
Telephone/ Communications	Verizon	Communication duct banks exist beneath the southbound lanes of Crystal Drive. Service connections come off this duct bank to feed adjacent properties.
Water	Arlington County	Underground distribution lines and service connections are at various locations. Pipe size varies from 1" to 12". Fire hydrants are located around the project area.
Storm Drainage	Arlington County	Storm runoff on roadway surface is conveyed by gutters to catch basins beyond the limit of survey. An existing underground 24-inch RCP storm drain runs through the site and connects to the larger drain that runs south to north, beginning at the roadway centerline and progressing beneath southbound lanes.
Street Lighting	Arlington County	Street lighting is throughout the project limits. Luminaires are cobra head-style, mounted on aluminum poles.
Traffic Signals	Arlington County	Standard traffic signals and control cabinets are around the project and are typically surface mounted on a stand-alone pole or foundation. Underground facilities including manholes, hand holes, and conduit are also present to services the above-ground equipment.

Figure 18 | Existing Utilities

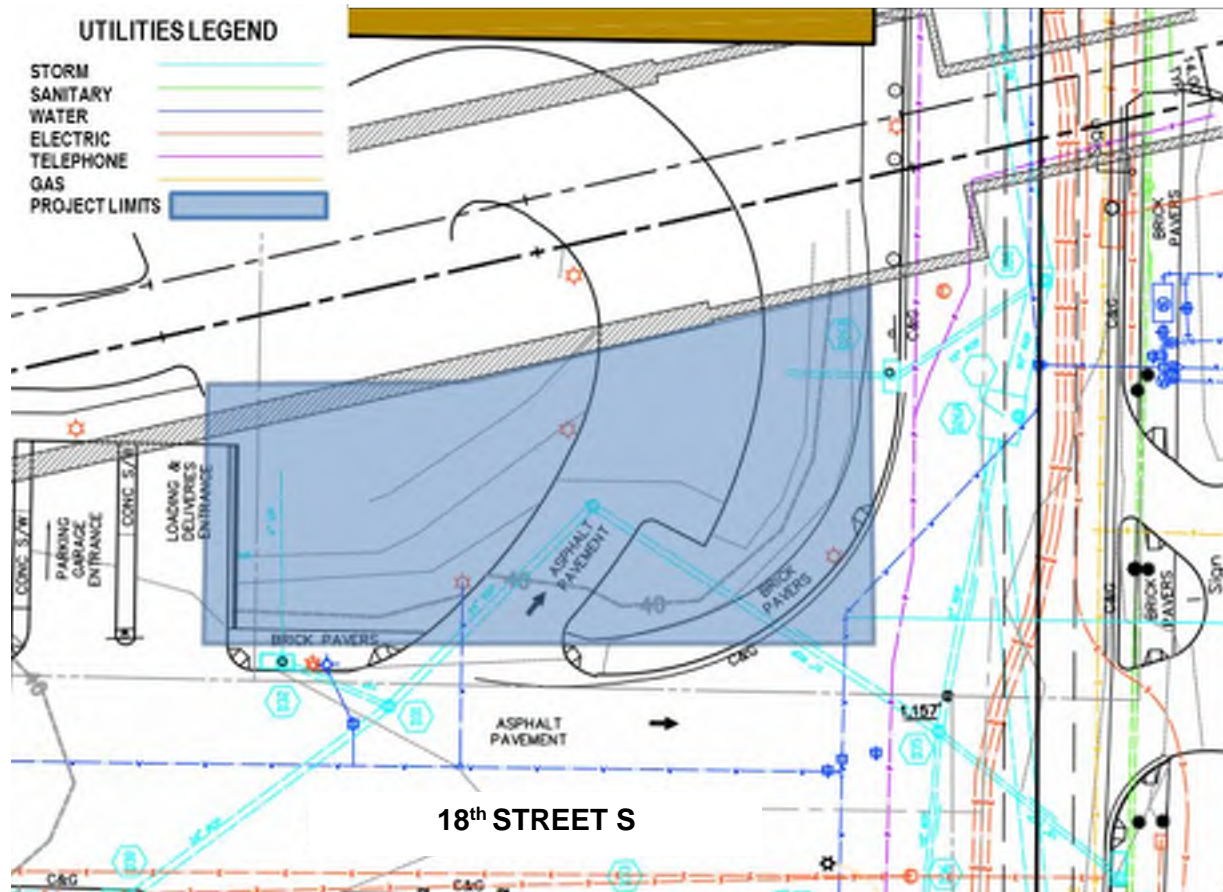

Source: Arlington County Existing Utilities (2007)

4.2 Geotechnical and Structural Analysis

4.2.1 Geotechnical

To evaluate the impact of the proposed second entrance on the existing geotechnical conditions, as-built drawings C8a-SO-1 to C8a-SO-7 were used as reference.

Previous soil boring PH-9U performed in the area of the new improvements indicates that about 14 feet of loose fill soils are present at the ground surface. The upper fill soils are underlain by generally compact sand and gravel soils with intermittent clay layers to a depth of 46 feet (extending to El. -7). The compact sand and gravel soils are underlain by very stiff clay soils to the depth of the maximum depths of the borings. **Figure 19** shows the general existing soil conditions in relation to the proposed second entrance mezzanine structure.

Current plans call for a mezzanine with a finished floor at about El. +10 and new elevators that will extend down to approximately El. -6. It is anticipated that compact sand and gravel soils are present at the level of the proposed mezzanine. It is anticipated that the mezzanine and the

street-to-mezzanine elevators can be supported on spread footings or mat foundations designed for moderate bearing pressures.

Support of Excavation (SOE) systems will be needed. It is feasible to install conventional steel H-pile and wood lagging SOE systems. The SOE system will need to provide horizontal stability of existing Metro structures during construction. Ground water is expected within the sand and gravel material at the Mezzanine level at El. +10. Therefore, dewatering of excavations will be needed during construction.

It is likely that the existing Metro facilities were constructed using steel H-pile and wood lagging excavation support systems. Normally the upper six to eight feet of the steel H-piles are removed at the end of construction, while the lower portions of the steel H-piles are left in-place. Therefore, it is likely that existing piles are still in-place, which could result in conflicts with the new construction. Also, the existing construction could have been constructed up against the old SOE system, or there could have been a three- or four-foot gap between the SOE system and the existing construction. Therefore, it will be prudent to determine and evaluate where there may be conflicts with old SOE systems. Test pits are recommended for the next phase of engineering design to confirm the presence of old SOE systems.

Figure 19 | Existing Soil Conditions

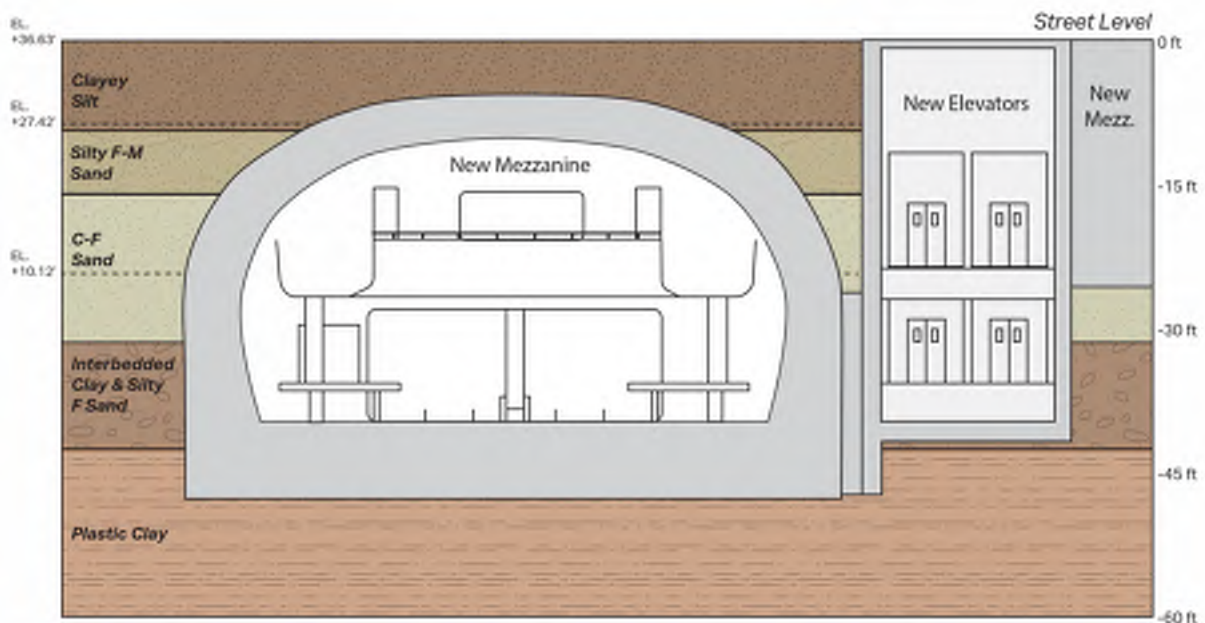

4.2.2 Structural

To evaluate the impact of the proposed second entrance on the existing structural conditions, as-built drawings C8a-S-1 to C8a-S-144 were used as reference.

The new Crystal City Second Entrance will be located adjacent to the existing East Service Room structure of the station. The East Service Room structure consists of reinforced concrete walls, floors, and roof (see **Figure 20**). The exterior walls are 2'-6" to 3'-0" thick and the roof slab is 2'-3" thick. The Upper Level floor thickness is 1'-6".

The existing train room structure consists of reinforced concrete arch vaults with reinforced transverse concrete ribs. The arch vault wall thickness ranges approximately from 6'-0" to 4'-0" (see **Figure 21**) and the width of the panels is 8'-4". The transverse ribs vary in depth along the arch vault and are 11" wide.

The structural work includes design and construction of a new Crystal City Second Entrance and modifications to the existing Crystal City station to accommodate the fit-out of the new second entrance. The new entrance will be directly below the proposed private developer building. It is recommended in order to streamline the design of the new entrance structure and to be fully coordinated with the private development above that the design of the new entrance and the fit-out of the new entrance and modifications to the existing Crystal City station would be by done by one single designer.

Figure 20 | Cross Section of Existing Crystal City East Service Room Structure

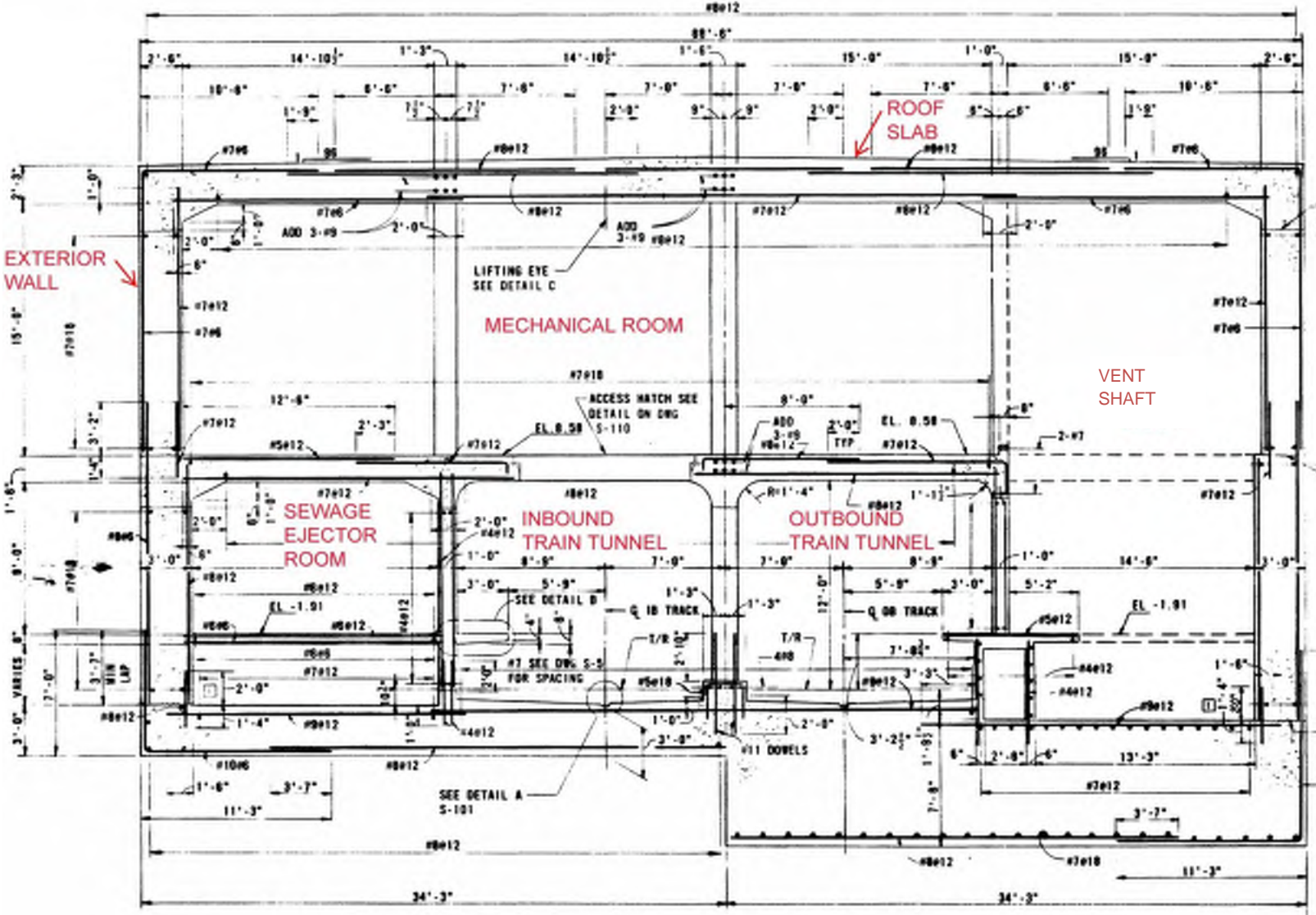

Source: METRO record drawings, sheet C8a-S-107.

Figure 21 | Cross Section of Typical Vault Arch

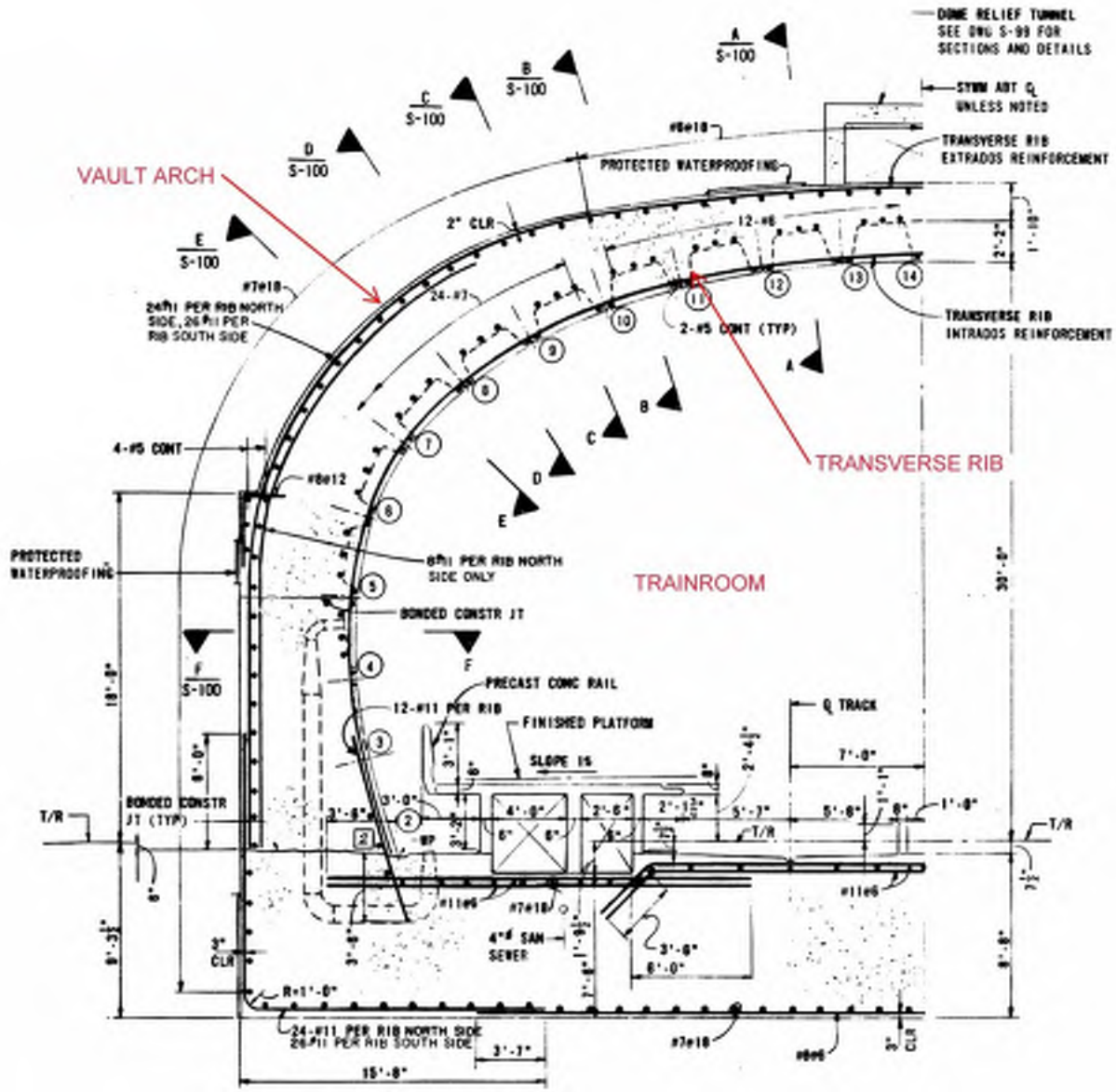

Source: Metro record drawings, sheet C8a-S-66.

4.2.3 New Elevator Machine Room

The new elevator machine room will be sited on top of the existing East Service Room structure. To accommodate the new machine room, a portion of the existing egress stair will be demolished. The existing door opening from the vent shaft to the egress stair will need to be modified. The new door opening will be located at the same approximate location but at a lower elevation, so a portion of the existing opening will need to be infilled and a portion of the existing wall will need to be removed for the new opening. A new access hatch for the egress stairs will be installed in the plaza adjacent to the existing vent shaft.

4.2.3.1 New Openings

A new opening will need to be cut through the station vault arch structure to provide access from the new mezzanine-to-platform elevator on the outbound track side. Prior to cutting the new opening, a reinforcing concrete collar will be installed on the outside of the vault structure (see **Figure 22**). The new penetration will be 6' wide and located between two existing ribs and is located one rib spacing away from the existing contraction joint in the vault arch structure and will not cut through any structural ribs.

Two new wall openings through the existing East Service Room structure will be required to provide passageway access from the new station entrance to the existing Crystal City train room (see **Figure 23**). One opening is through the south exterior wall of the East Service Room and another is through the end wall between the train room and the East Service Room area. Both openings will be supported by new lintels and are at the mezzanine level. The new opening through the station end wall is directly above the outbound and inbound train tunnels. The existing end wall is sufficiently reinforced to support the new 15' wide passageway opening but does not have additional capacity to support the new mezzanine. There is also an opening through the station end wall at the platform level that will be supported by a new lintel. The new opening provides access from the new mezzanine-to-platform elevator that will be in the existing duct shaft on the inbound track side of the East Service Room structure.

4.2.3.2 New Mezzanine

Within the existing train room, a new mezzanine will be constructed. The new mezzanine structure will consist of composite steel beams supporting metal decking with concrete infill. The new mezzanine structure will be limited in depth in order to maintain vertical clearance requirements at the station platform. The composite steel beams will be supported by new steel columns that will penetrate the existing concrete platform and be supported by the invert slab below. The steel framing and metal decking construction is proposed to mitigate/reduce track work disruptions. New columns will be required to support the new mezzanine structure because the existing station end wall is not sufficient to support the mezzanine with the new passageway opening through the wall.

Figure 22 | Partial Plan of Train Room on Outbound Track Side

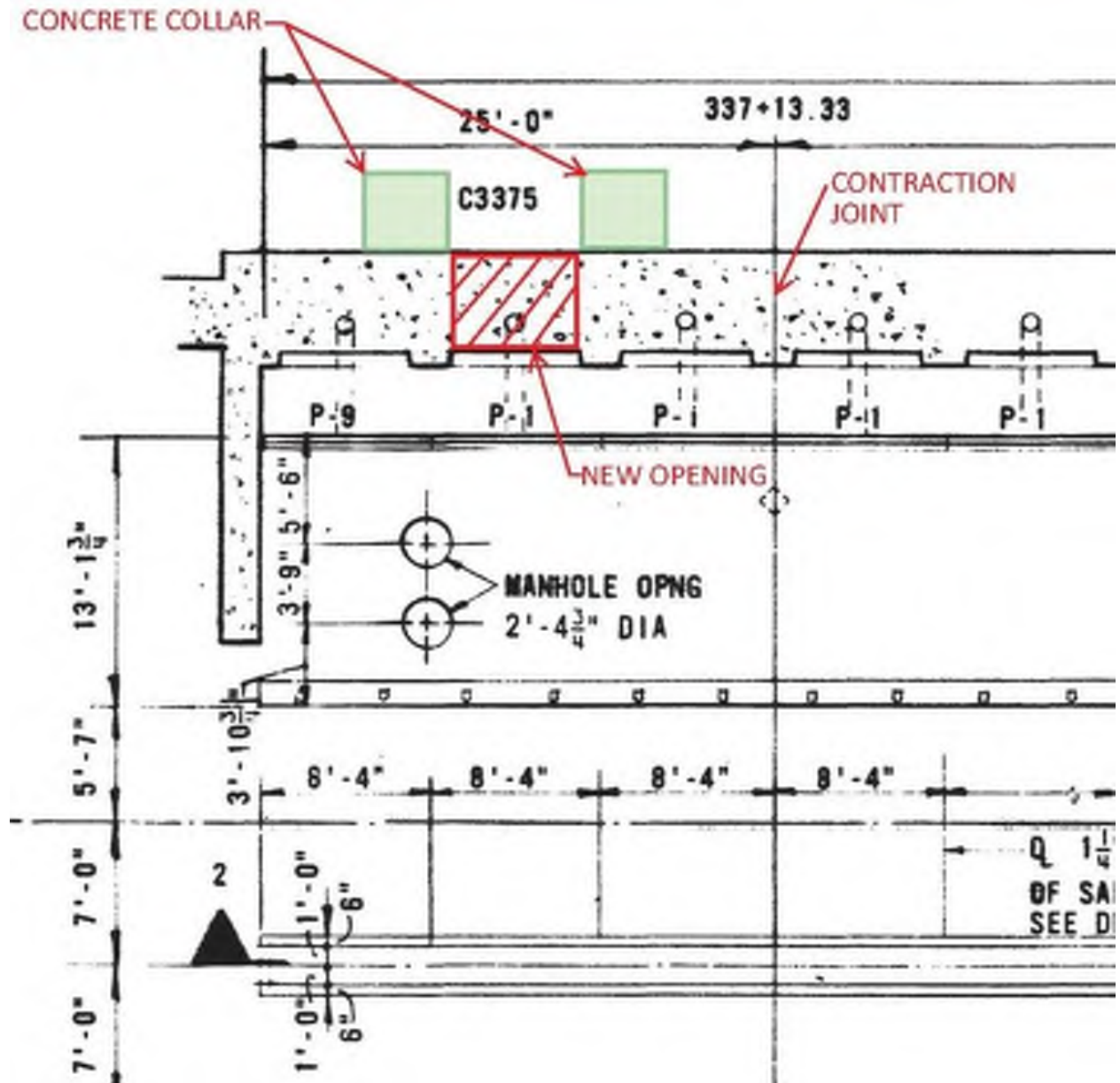

Source: Metro record drawings, sheet C8a-A-3.

4.2.4 East Service Room Structure Modifications

There are modifications required to the existing East Service Room structure. The new mezzanine-to-platform elevator requires demolition of the existing 1'-0" thick concrete wall between the duct shaft and sewage ejector room at the platform level. The new elevator width will not fit within the existing wall spacing; therefore, the existing wall will be removed, and a new elevator shaft wall will be constructed that accommodates the width of the new elevator. There should be adequate depth between the top of the platform slab to top of invert slab for a new elevator pit. If new sump pits are required, the design and installation will need to be investigated (see Section 4.3.2 for discussion of elevator design). The existing invert slab cannot be cut through due to waterproofing concerns.

At the Upper Level of the East Service Room structure, the 1'-0" thick concrete wall between the existing duct shaft and stairwell on the outbound track side will need to be demolished to accommodate the new passageway that will connect the new station entrance to the train room. The existing stairwell opening at the Second Level of the East Service Room structure will need to be infilled along with a section of the adjacent existing duct shaft (see **Figure 23**). A portion of the existing duct shaft will be left open to run new ductwork. On the inbound track side of the East Service Room structure, the existing 1'-6" thick floor slab will need two new penetrations: one penetration for the new platform elevator and a second penetration for a new duct shaft (see **Figure 23**). Adjacent to the new elevator opening is an existing duct opening through the floor that will need to be infilled.

Figure 23 | Second Level Plan of East Service Structure

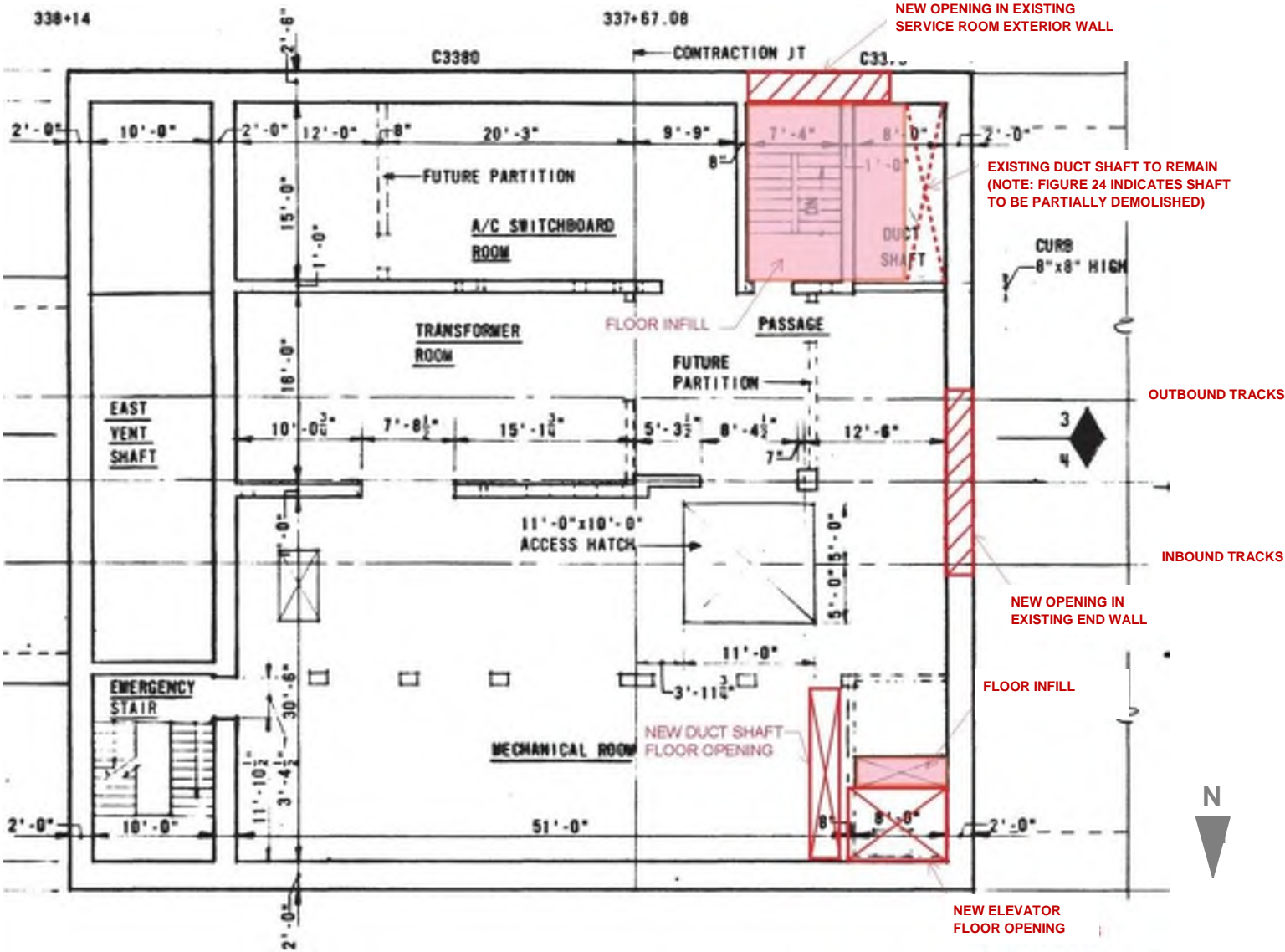

Source: METRO record drawings, sheet C8a-A-9.

4.3 Mechanical Systems

The new Crystal City Second Entrance will require modification to existing mechanical systems and new mechanical equipment to support the additional station space. The requirements regarding the heating, ventilating, and air-conditioning systems that must be addressed in the design of a second entrance are outlined in this section. This evaluation was based on Metro record drawings from both the M71 and the M77 drawing sets used for the original construction. The drawings from the M77 set included M-1, M-2, M-6, M-12, M-13, and M-17. The drawings from the M71 set included M-10, M-15, A-8, S-65, S-66, S-67, S-94, and S-107.

4.3.1 Impact of New Platform Mezzanine and Passageway

The proposed location for the new passageway between the new entrance mezzanine and the new station mezzanine takes floor area from the existing mechanical room on the second level. The space needed for the new passageway is currently used for ductwork that crosses from the mechanical equipment on the north side of the mechanical room to the south side to serve the outbound passenger platform. This ductwork consists of three ducts: an air-conditioning (AC) supply air duct, an AC return air duct, and an UPE air duct. These three ducts go down through penetrations in the mechanical room floor and then through penetrations in the track level platform. There are two air handling units in the mechanical room: one serves the inbound platform and one serves the outbound platform.

With the new mezzanines and passageway, these ducts serving the outbound platform will need to be re-routed between the top of the new passageway structure and the underside of the existing third level floor slab. This will limit the potential height of the new passageway ceiling since a clear zone of at least 30" deep will be required for this ductwork (see **Figure 24**). The mechanical room height is approximately 15' – 0" from top of slab to underside of the slab above. The ducts will be routed down through the new chase adjacent to the new passageway and into the existing ductwork below the track level platform (see **Figure 25**).

Figure 24 | Passageway Ceiling Clearance for Duct Work

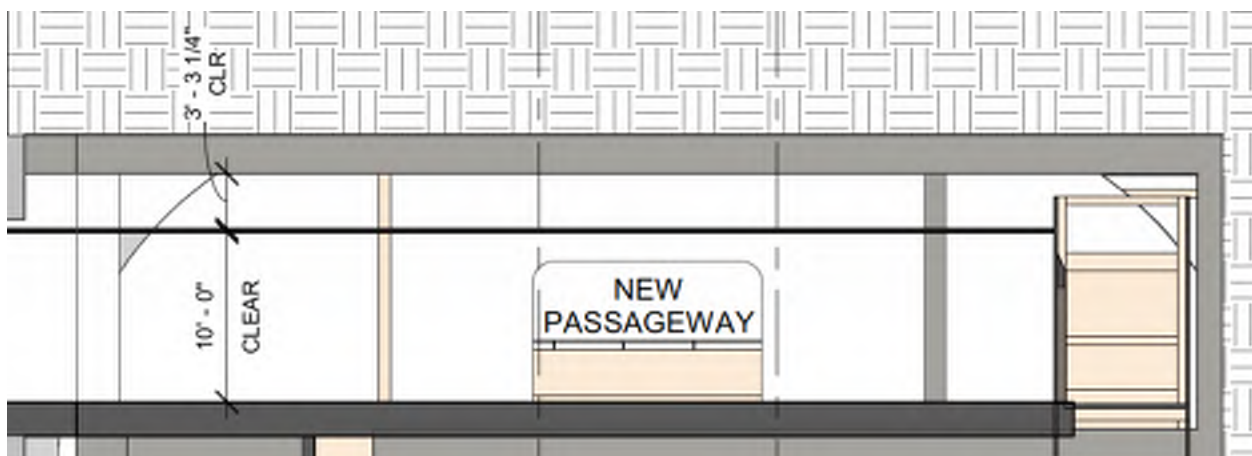

Section through passageway looking west. Ceiling clearance for duct work is 39" and passageway height is 10'.

4.3.2 Impact of Platform Elevators

The proposed outbound platform elevator pair is not anticipated to have major impacts to the existing station mechanical systems since the elevators are located outside of the station vault. The supply ducts are imbedded in the vault structure and discharge above while the return air goes directly into the under-platform plenum from grilles below the platform. The new vault opening for the outbound platform elevators may interfere with one of the branch supply air ducts embedded in the vault structure; however, it is not anticipated to impact the rest of the cooling system.

The proposed location for the new inbound platform elevator will take significant floor area from the west side of the existing mechanical room on the second level. The elevator will be located where the existing ducts serving the inbound passenger platform pass through the mechanical room floor slab. Like the outbound side, these penetrations are for an AC supply air duct, an AC return air duct, and a UPE air duct. The combination of the new passageway and new elevator will impact a large enough portion of the mechanical room that all equipment in the room will need to be reconfigured (see **Figure 25**). One possible option for maximizing the reduced space will be to replace the two air handling units with a single larger air handling unit.

Figure 25 | Reconfigured East Service Room

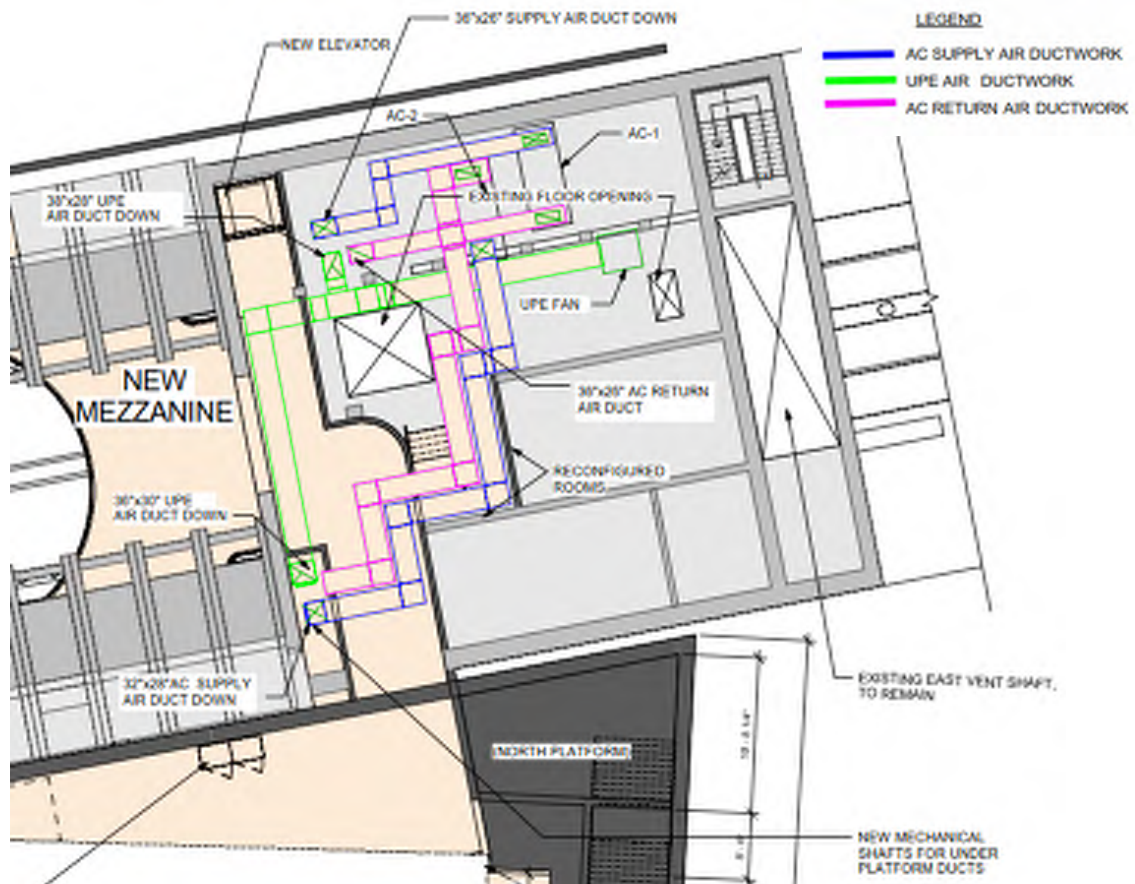

A new duct shaft will be needed to replace the one eliminated by the new elevator shaft. This shaft will be adjacent to the new elevator shaft. This shaft will pass through the existing sewage ejector room and penetrate the track level platform east of the elevator. This routing will be difficult to accomplish and will likely require substantial demolition and repair of the passenger platform to make the required duct connections. In addition, the new duct chase will take substantial space from the existing sewage ejector room and will require that the equipment in this room be reconfigured (see **Figure 26**).

4.3.3 Cooling

The new entrance public spaces will add significant cooling loads to the station in the form of ventilation, passengers, and lighting. The existing chiller cannot support the additional new cooling loads. These loads in the entrance mezzanine and passageway will be served by a new air handling unit located in the mechanical room in the upper level of the new entrance mezzanine space. The new loads in the station mezzanine will be served by the air handling units in the existing main mechanical room. Per Metro guidance, the three new elevator machine rooms should always be air conditioned (however, there is some flexibility when space is constrained), so they represent a year-round cooling load. The two mezzanine machine rooms can either be served by the new air handling unit or by their own smaller units. The north machine room can be served by the existing mechanical room air handling units or by its own unit.

The cooling source for the new air handling unit and any separate elevator machine room units will be either chilled water or by new direct expansion system(s). If chilled water is used, then additional chilled water will be required from a new air-cooled chiller. It should be confirmed during the design phase that the existing Crystal City chiller plant does not have spare capacity. The new air-cooled chiller will have to be in a suitable outdoor location relatively close to the new entrance. Options for siting a new air-cooled chiller are limited so the rooftop of the proposed adjacent two-story retail building would be the ideal location. If direct expansion systems are used for any of these units, they will also require one or more outdoor heat rejection units. The potential locations for these outdoor units are less flexible than the potential locations for the air-cooled chiller due to restrictions on the length of refrigerant piping that connects the outdoor and in-station units. The ideal solution is to provide a new air-cooled chiller allowing greater location flexibility. Additionally, it could also be tied into the existing chilled water system to provide additional capacity for the existing systems.

Figure 26 | Reconfigured Sewage Ejector Room (Platform Level)

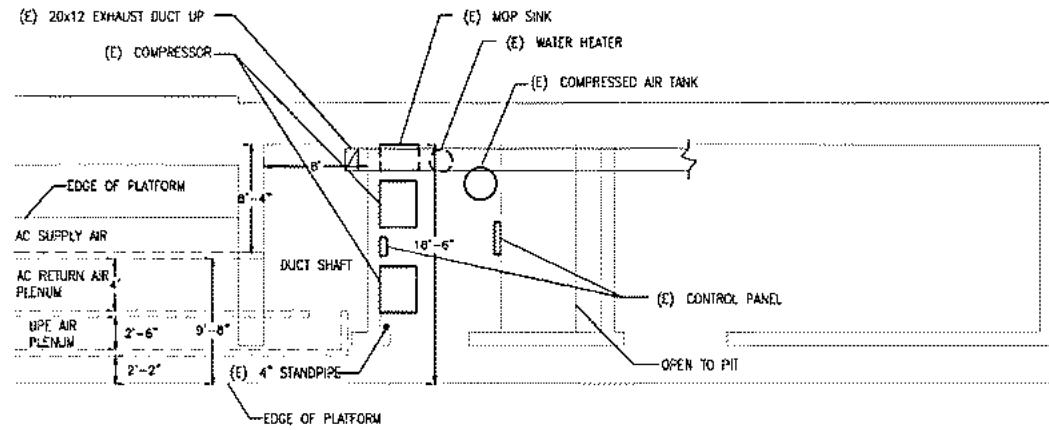

PLAN VIEW-EXISTING DIMENSIONS

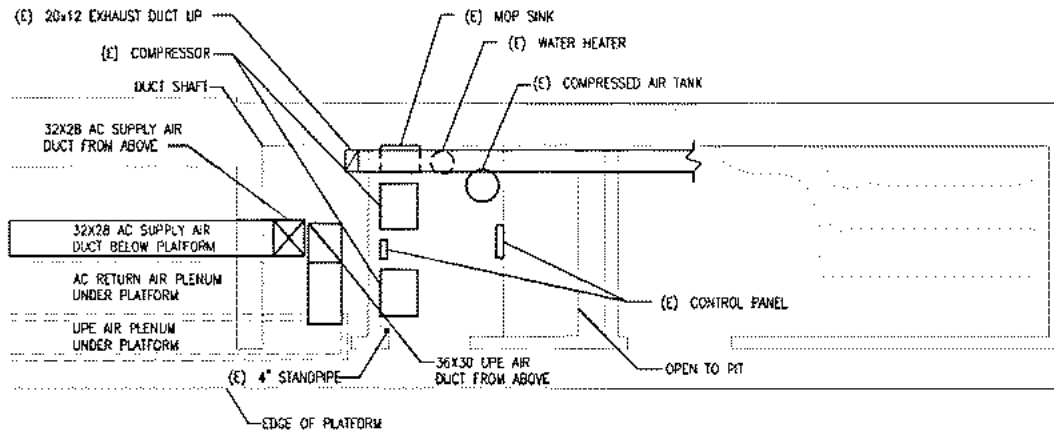

PLAN VIEW-EXISTING CONDITIONS

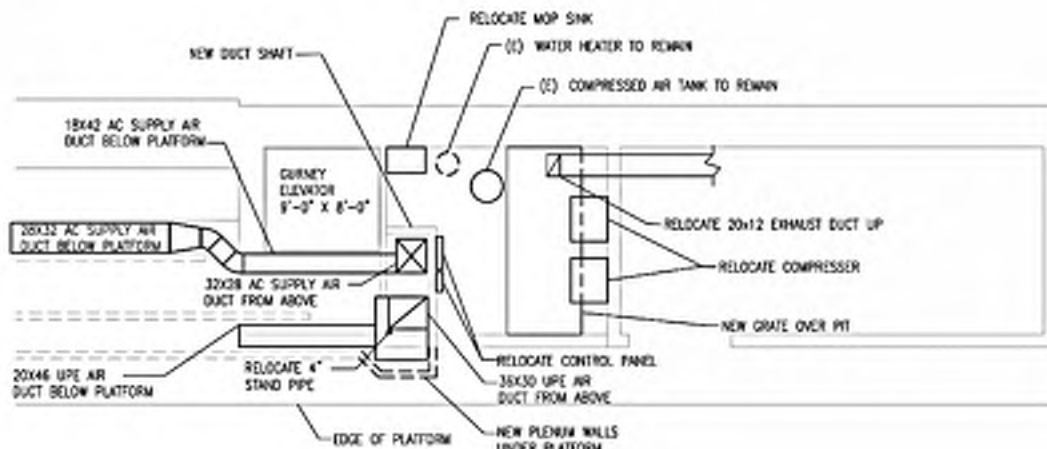

PLAN VIEW-PROPOSED CONDITIONS

4.4 Electrical Systems

To evaluate the impact of the proposed addition of new elevators, mechanical systems, and other new station functions (lighting, communications, fare vending and payment, etc.) on the existing electrical system, as-built drawings C8a-E-1 to C8a-E-18 were used as reference.

The station utility power is fed from two sources. One source feeds power to the substation located at the east end of the station, and the other source feeds power to the substation at the west end of the station. Both utility feeds serve power at 34,000V. The power is then stepped down to 480Y/277V via a 1000kVA transformer at each substation. The east and west substations are in the East AC Switchboard Room and the West AC Switchboard Room, respectively. The switchgear equipment at the east and west substations are connected to each other via tie breakers. The conduits and cables that connect the two tie breakers are run below the platform in the air plenum.

Below is a list of assumptions that were made when evaluating the impact of the proposed elevators on the electrical system. These assumptions should be verified during the design process.

- Adequate available power capacity exists at the station to accommodate the new station elements that are proposed to be added as part of the renovation project.
- Spare breaker or space to add a new breaker exists at the East AC Switchboard. Any spare breakers can be replaced to serve as new panelboard for the new station elements.
- A new 480/277V panelboard, fed from the East AC Switchboard and located in the new elevator machine room, will be added to serve the new elevators, and other miscellaneous loads associated with the new station elements.

The station does not have an on-site emergency backup generator. It is served by two electric utility services, one on the east side and another on the west side. If one utility source fails, the tie breakers can be closed to run the station using the other functioning utility source. Both utility power sources will have to be interrupted for the elevators to lose power. Emergency lighting will be fed from the existing emergency panel, which currently serves the existing entrance elevator. The station emergency panels are backed up by an uninterruptible power supply (UPS)/battery backup power sources. All new normal and emergency lighting fixtures that will be added as part of the proposed project will utilize energy saving LED fixtures.

To proceed with the proposed recommendations, available spare capacity to serve the new electrical loads must be verified. If it is determined that there is not adequate spare capacity to accommodate the new loads, breakers, panelboard and switchboards need to be added or upgraded to accommodate the new electrical loads. Verification of available spare capacity can be done by metering the electrical services or by using recent historical metered data. The estimated additional electrical load is summarized in **Table 2**.

Table 2 | Estimate of Electrical Load Added to the Station

Electrical Loads	Quantity	Normal Load					
		Connected Load			Demand	Demand	
		KVA	AMP	HP	FACTOR	KVA	AMP
Elevator (40 HP)	5	43	52	40	80%	173	208
Sump Pump (1 HP)	4	2	2	1	80%	6	7
Miscellaneous	1	5	6		100%	5	6
Lighting Total	1	5	6		100%	5	6
HVAC	1	12	14		80%	9	11
Diversity						95%	
Net Total Added Electrical Load on Facility						188 KVA	226 AMP

4.5 Communications

The new Crystal City Second Entrance will require additional communications equipment including signage, passenger information display system (PIDS), public address system, emergency telephone, and closed-circuit television (CCTV). All of these systems are present at the existing station entrance and should be extended to the proposed second entrance in accordance with the Metro Manual of Design Criteria.

On the inbound platform, existing communications equipment located against the end of platform wall will need to be relocated to accommodate the proposed mezzanine elevator. This equipment can likely be relocated to the outbound platform. Additionally, the infill of the existing service stair and landing on the outbound platform provides additional ancillary space that can be used as a communications room on the platform level.

4.6 Egress Analysis

This section summarizes the effect of the proposed second entrance on the Crystal City Metrorail Station egress from the public areas of the station. The detailed Egress Analysis Technical Memorandum and Spreadsheet Calculations are seen in **Appendix C**. The applicable codes and standards for this analysis include the following:

- National Fire Protection Association: NFPA 130, Standard for Fixed Guideway Transit and Passenger Rail Systems, 2017 edition.
- 2012 Virginia Construction Code (VCC) (Part I of the Virginia Uniform Statewide Building Code), based on the 2012 edition of the ICC/International Building Code (IBC).
- 2012 Virginia Rehabilitation Code (VRC) (Part II of the Virginia Uniform Statewide Building Code), based on the 2012 edition of the ICC/International Existing Building Code (IEBC).

The approach to the application of fire life safety codes and standards for the design of the Crystal City Station improvements is based on the use of NFPA 130 in conjunction with the Virginia Construction Code, as applicable to the alteration of an existing rail station. NFPA 130, Standard for Fixed Guideway Transit and Passenger Rail Systems, is a nationally recognized fire life safety consensus standard. NFPA 130 fire life safety criteria take precedence over the corresponding criteria of the Virginia Construction Code. NFPA 130 timed egress criteria are

applied in evaluating the means of egress from the public areas of the station. All new construction elements, components, systems, and spaces are designed to comply with the requirements of the Virginia Construction Code, except where NFPA 130 criteria apply.

The Crystal City Metrorail Station Second Entrance concept design and additions require that the NFPA 130 egress analyses demonstrate improvement to means of egress that is achievable within the constraints of the existing station and station site and is acceptable to the Authority Having Jurisdiction (AHJ).

4.6.1 Conclusions

Based on platform occupant loads derived from the 2040 passenger demand forecasts (2015 study) and the projected train headways, the NFPA 130 timed egress spreadsheet calculations (see **Appendix C**) summarized in the **Table 3** below, indicate:

- The preferred design shows significant improvement to the evacuation performance of the existing station, both for the platform evacuation time and the evacuation time to a point of safety. Therefore, the preferred design meets the evacuation timed-egress criteria as applicable to an existing station.
- Both the existing station and the preferred design comply with the NFPA 130 maximum travel distance of 325 feet to the nearest egress point on the platforms.
- Neither the existing station nor the preferred design meet the NFPA 130 maximum platform common path travel distance of 82 feet. The preferred design does not improve the common path travel distance.

Table 3 | NFPA-130 Time-Egress Spreadsheet Calculations – Summary Table

Scenario	Longest Travel Distance to Nearest Egress Point on Platform (feet)	Longest Common Path of Travel from End of Platform (feet)	AM Peak				PM Peak			
			Platform Evacuation Time (minutes)		Evacuation Time to a Point of Safety (minutes)		Platform Evacuation Time (minutes)*		Evacuation Time to a Point of Safety (minutes)*	
			Peak-Direction (NB) Platform	Non-Peak-Direction (SB) Platform	Via West Mezz	Via East Mezz	Peak-Direction (SB) Platform	Non-Peak-Direction (NB) Platform	Via West Mezz	Via East Mezz
No-build	210	210	8.78	2.48	15.17		7.13 (7.74)	3.78	14.81 (15.49)	
Build	210	210	5.89	1.66	11.57	7.42	4.78 (5.19)	3.19	11.35 (11.85)	6.32 (6.73)

*Note: numbers in parentheses are the calculated times when a maximum train capacity of 1400 (the AW2 loading for Series 7000 trains) instead of 1280 (the maximum train capacity per the Metro Manual of Design Criteria) is used.

5 Constructability

This section summarizes the assumptions and preliminary findings for constructing a second entrance at the Crystal City Metrorail Station and includes:

- Constructability review focused on high-profile elements of work including underground utilities, foundations, and underground construction;
- Evaluation of each element’s design practicality and economy to develop schedule and potential construction considerations;
- Baseline sequence of construction for each major element;
- Identification of characteristics of the construction sequence or environment that would influence the project’s cost, potential contractor pricing, and construction; and
- Implementation considerations, including project risks and recommended potential actions to facilitate construction.

Overall project constructability is achievable. **Table 4** summarizes the project elements which pose potential risks. See Section 5.3 for additional discussion of key implementation considerations and other potential high-level risks to schedule and cost.

Table 4 | Major Project Elements Driving Schedule, Cost, and Risk

Project Element	Implementation Considerations
Interface Agreement between Metro and the Developer	<ul style="list-style-type: none"> – Address permanent easement for new station entrance related to the overbuild. – Define roles and responsibilities and decision-making for design and construction.
Design	<ul style="list-style-type: none"> – Metro develop Basis of Design to define project blueprint for developer’s designer. Developer’s designer shall adhere to the Basis of Design. Include in interface agreement. – Metro should define the Design QC program and provide Design quality oversight. Include in interface agreement. – Clear scope requirements for design should be determined early in the project between Metro and the developer.
Support of Excavation (SOE)	<ul style="list-style-type: none"> – Regarding the existing Metro structure: Metro shall identify what can/cannot be done, particularly related to waterproofing of the tunnel.
Metrorail Service	<ul style="list-style-type: none"> – Maintaining Metrorail service will limit construction access to the platform and mezzanine areas to nights/weekends.
Metro Systems	<ul style="list-style-type: none"> – Mechanical/Electrical (ME) phasing plan is required before construction can begin. It should protect critical Metro systems, protection from stray current, and integrate existing and permanent ME systems. – Modifications required to support construction activities, e.g. tie-ins to utility feeds. – Complete fit-out will change existing systems and add major equipment, including elevators, a new air chiller, escalators, communications, Fire Life Safety, information systems, and power supply.

5.1 Constructability Review

This section provides a preliminary constructability review and focuses on major construction elements associated with underground construction. Specialty elements of work and advanced procurement elements are also considered. Future environmental review and engineering analysis will refine the construction elements for a more detailed constructability review.

The review identifies zones where the project will impact adjacent uses and infrastructure. The project will need to consider and monitor these impact zones during the design and construction of each phase, respectively.

The following is a description of each impact zone.

5.1.1 Site Access

Access to surface/subsurface rights is required for construction and operation of the project. It is necessary to obtain easements and permits and execute agreements before construction can begin. For example:

- This conceptual analysis presumes that the mezzanine shell can be built under the proposed development on the south side of the station.
- During engineering and design, construction staging and laydown areas will be identified and evaluated. This conceptual analysis presumes that once the mezzanine shell is built, it can be used as contractor laydown area, with the new street-to-mezzanine stairs providing access for material to construct the new mezzanine, e.g. formwork, reinforcing steel, and concrete. This approach will minimize impact to the overbuild.
- Prior to start of construction, the project is required to have the Maintenance of Traffic (MOT) Plan in place.

5.1.2 Street Level

Construction of the second entrance may disrupt sidewalk and street functions. Disruptions will include sidewalk closures, lane closures, and traffic detours during major construction activities. The project needs to have an approved MOT Plan and agreements in place prior to construction. Existing driveways adjacent to the project will also need to be considered including the parking garage to the west of the proposed new station entrance (see **Figure 27**). Existing driveways must be maintained, or alternate access to existing adjacent uses must be provided, throughout construction.

Figure 27 | Adjacent parking garage entrance

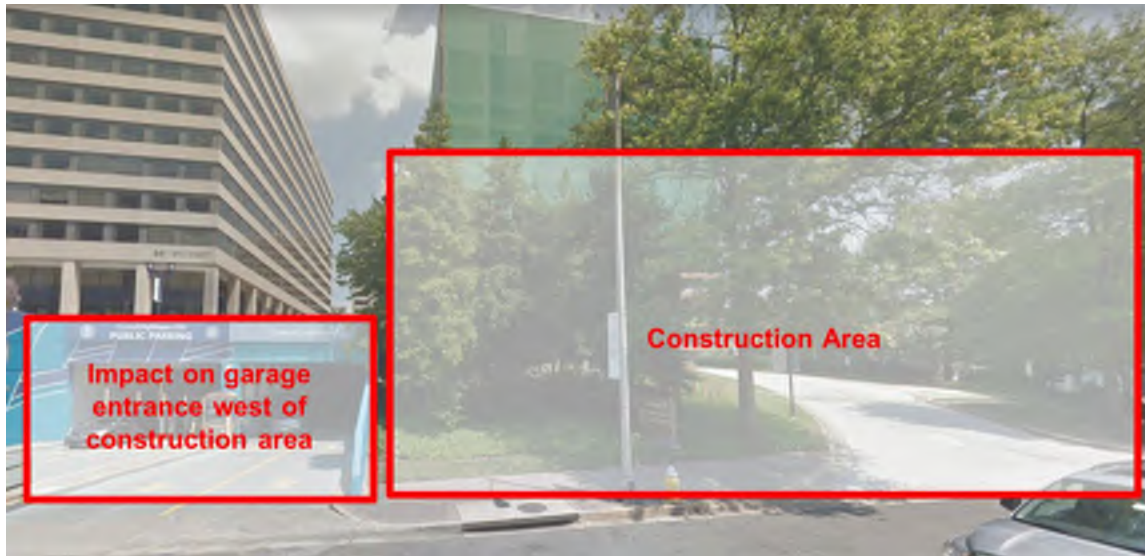

5.1.3 Adjacent Underground Infrastructure

The project involves construction in an urban environment and needs to account for underground infrastructure that includes:

- **Utilities.** Based on a review of record drawings, the second entrance will avoid major utility impacts. Preliminary engineering will include further investigation and coordination to identify impacts to existing utilities, evaluate design solutions to minimize or avoid impacts, and define potential tie-ins required to support construction and operations of the second station entrance. The project includes placing SOEs and major excavation; as such, this constructability analysis anticipates coordination between the developer, Metro, Arlington County, and utility owners as part of the development project.
- **Existing Station.** Protection of the existing station is paramount during construction to ensure the structural integrity of the station vault structure and East Service Rooms is maintained. Constructability considerations are described below. See **Figure 28** and **Figure 29**.
 - Support of Excavation (SOE) – Placement of SOE systems are for the new mezzanine shell and new elevator machine room for the inbound mezzanine-to-platform elevator (see **Figure 28**). Waterproofing and structural supports at tunnel interfaces (new mezzanine shell and new elevator machine room) are the primary areas of concern. The project should establish the condition of existing structures including the vault SOE during preliminary engineering.
 - Modifications to existing Metro structures – Includes structural modifications to open the vault, end wall, and floor of the service structure to construct the new mezzanine (see **Figure 29**). This work requires coordination with other station functions including mechanical/electrical systems and train operations, described below.

5.1.4 Existing Mechanical and Electrical Systems

A phasing plan is required before mechanical and electrical (ME) work can begin, to facilitate continuity of ME functions.

- The ME systems phasing plan will ensure Metrorail critical functions (e.g. signals and communications) are uninterrupted during construction of the second entrance;
- Other Metrorail ME systems will require modifications to support construction activities (e.g. tie-ins to utility feeds); and
- The reconfiguration of existing ME rooms and equipment will occur after the new mezzanine shell and structural collars are in place. This work requires significant construction access for the new mezzanine within the existing vault. This approach allows the integration of the new ME system into the existing system effectively and should minimize staging for the required ME room and equipment reconfiguration as described below:
 - Reroute ductwork. The new passageway between the new entrance mezzanine and new platform mezzanine requires relocation of three existing ducts (AC supply, AC return, and UPE air). These three ducts go down through penetrations in the mechanical room floor and then through penetrations in the track level platform. Reconfiguring the outbound platform ducts may require some temporary disruption of the passenger platform to accommodate the new duct routing.
 - Reconfigure existing mechanical equipment. The combination of the new passageway and new elevator will impact a significant portion of the existing mechanical room so that all equipment in the room will need to be reconfigured (Figure 14 in Section 4.3.2). Equipment to reconfigure includes replacing two smaller existing air handling units with one larger unit, a duct shaft, and a duct chase (currently in the existing sewage ejector room).
 - Provide additional cooling loads. The new entrance public spaces and elevator machine rooms will add significant cooling loads. The loads in the entrance mezzanine and passageway will be served by a new air handling unit located in the mechanical room in the upper level of the northeast corner of the new entrance mezzanine space. The cooling source for the new air handling unit and any separate elevator machine room units will be either chilled water or by new direct expansion system(s).

5.1.5 Train Operations

This constructability review assumes maintaining station facility operations during construction, with minimal train and station operational impacts.

- Work within the existing Metro tunnel requires a Maintenance of Operations Plan (MOP). This plan will address elements such as advanced coordination of station closures with a train bypass.
- The new mezzanine structure will consist of composite steel beams supporting metal decking with concrete infill. The composite steel beams will be supported by new steel

columns that will penetrate the existing concrete platform and be supported by the invert slab below. The steel framing and metal decking construction is proposed to mitigate and reduce track work disruptions.

- Mezzanine construction work would be limited to non-revenue hours and selected weekends. Equipment and materials will be brought in via work trains and street-to-mezzanine stairs (temporary underground construction access).

5.2 Sequence of Construction

This section describes a preliminary baseline sequence of construction for the purposes of developing the conceptual project schedule. Each construction element will be built in a certain sequence. As additional design and analysis progress, the sequence of construction will be refined.

Figure 30 summarizes the high-level sequence of construction elements, highlighting the critical items that factor into the construction schedule. Construction monitoring will occur for the duration of project, including noise and vibration impacts to adjacent uses and structures.

Figure 30 | Overview of Construction Sequence

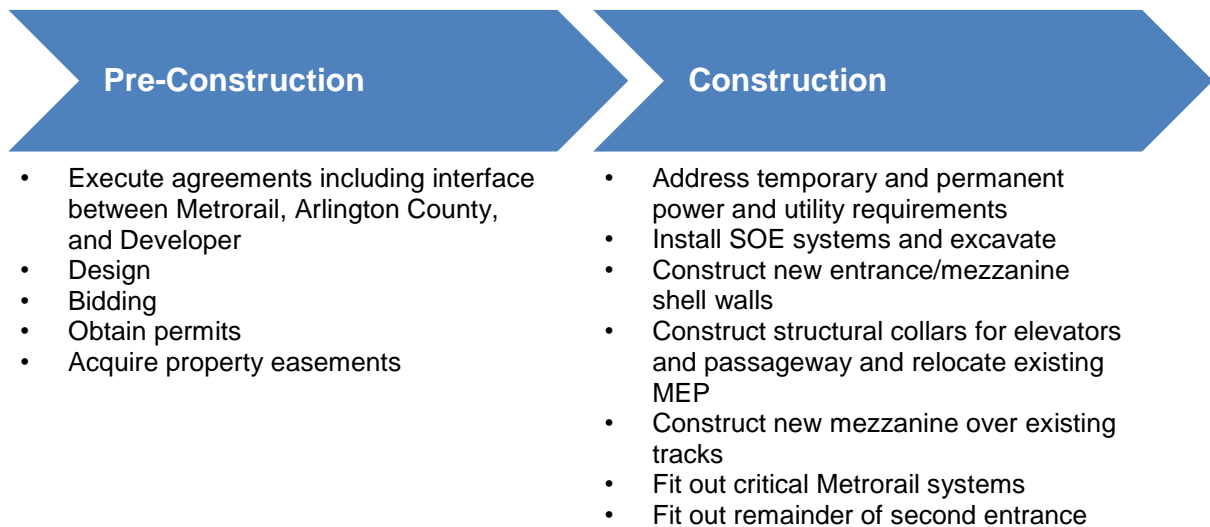

Prior to construction, the contractor must obtain property access rights including easements (surface or sub-surface) for construction and operation; and obtain permits and execute other agreements, including the MOT plan. The contractor must also determine the available capacity for permanent and construction power. If external temporary power is needed, the length of run and cost, as well as fume and noise mitigation measures, will need to be determined.

Next, the contractor will prepare for the construction of the new entrance shell and new elevator machine room. Support of Excavation (SOE) for the new entrance shell assumes augured H piles. Excavation adjacent to the platform area will need to be waterproofed. The SOE for the new mezzanine-to-westbound platform elevator machine room will be placed on top of the existing Metro tunnel (see **Figure 27** and **Figure 28**). Presumably, this SOE will use trench

boxes and bracing, and will involve attaching to the existing SOE for the Metro tunnel including waterproofing tie-in. Finally, the elevator pit will be excavated. Dewatering will be provided as needed throughout the excavation process.

After excavation has been completed, the contractor will install foundations for the walls and elevator pits. Blindsided waterproofing will then be applied to the mud mat, bottom slab, and sides of elevator and shell. All four walls will be built incrementally, bracing level by bracing level, with re-strutting done as necessary. The collars will then be cast up against the shell, the walls completed, and the roof placed. The roof will have a hole that will provide temporary underground construction access for work within the existing Metro tunnel.

During non-revenue hours, the contractor will cut through the braced station vault where the new mezzanine-to-platform elevator will be located. Temporary stairs will be needed to connect this new elevator collar to the new mezzanine shell. Concurrently, the contractor will relocate ME systems in the service rooms. Once the ME equipment relocation is complete and the temporary stairway egress has been established, the contractor will close the existing service room stairway. Selective wall demolition will connect the existing service area to the new mezzanine area.

The new mezzanine steel structure will be built inside the train room. The primary structure and stay-in-place forms will be built during non-revenue hours, while reinforcement and preparation for the concrete pour can occur during operational hours. The concrete will need to be poured during non-revenue hours.

Vertical circulation elements will need to be established to connect the new mezzanine to the platform and street levels. New mezzanine-to-platform stairs and elevators will be installed during non-revenue hours. Street-to-mezzanine elevators can be installed during operational hours. Other work done during operational hours includes fit-out of the mezzanine interior furnishings and remaining MEP elements. Then the temporary underground construction access must be closed, the final egress stair built, the roof backfilled, landscaping and at-grade finishes installed above collar ties, and elevators commissioned.

5.3 Implementation Considerations

This section describes key project implementation considerations and risks at this preliminary level of analysis. Future design and engineering of the second entrance will refine design, schedule, and budget to better identify and mitigate risks.

- **Interface agreement between Metro, Arlington County and the developer.** Address key aspects of the approach to implementation. This agreement has material impacts on the project scope, schedule and budget.
 - Define the permanent easement for the new station entrance relative to the overbuild, as well as maintenance of the space.
 - Define roles and responsibilities and decision-making during design, construction and commissioning of each phase. For example, Metro should define the developer QC program and provide quality oversight during design and construction.

- **Design.** This consideration has the following aspects that will be included in the interface agreement:
 - Metro shall develop Basis of Design to define project blueprint for developer's designer. Developer's designer shall adhere to the Basis of Design.
 - Metro shall define the Design QC program and provide Design quality oversight. Include in interface agreement.
 - Clear scope requirements for design should be determined early in the project between Metro and the developer.
- **Support of Excavation (SOE).** Perhaps the most significant risk associated with the SOE is the waterproofing of Metro's existing tunnel. Construction of the second entrance requires SOE for the new mezzanine shell and the new elevator machine room for the mezzanine-to-westbound platform elevator. To mitigate this, Metro's design criteria and specifications need to be included in the design package. In preliminary engineering, Metro should consider investigating the optimization of the elevator machine rooms to minimize the risk of water infiltrating the top of the existing Metro tunnel for the mezzanine-to-westbound platform elevator. Other potential risks include unforeseen geotechnical and subsurface infrastructure conditions that could impact schedule and cost.
- **Metro inspection contingency.** Due to the nature of the project, the conceptual schedule includes contingency for Metro's inspection before contract closeout can occur.
- **ME systems.** Modifications to existing ME rooms and the addition of new equipment such as elevators and an air chiller pose schedule risks. ME systems phasing should: protect critical functions of Metro systems (signals, communications, Fire Life Safety); ensure sufficient protection from stray current; and integrate existing and permanent ME systems. This project will also include executing cutover plans prior to initiating mezzanine work adjacent to the station platform and train operations.
- **Metrorail service.** Potential project risks related to Metrorail service include changes to operational requirements that further restrict working hours or track access after contract award due to service plan changes, availability of Metro forces (e.g. flaggers), special events, incidents, emergency maintenance, or operational restrictions to accommodate supplemental transit service. Development of the MOP should begin during preliminary engineering and completed during final design, before construction begins.

Other potential, high-level risks include:

- **Other agreements, permits:** In addition to the interface agreement between Metro and the developer, agreements and permits have direct effects on the project scope, schedule, and budget. Agreements with funding partners and permitting agencies require clear definition of roles and responsibilities and decision-making during design and construction by phase.
- **Contractor delays:** These may be compounded due to limitations to site and track access and may be caused by material delivery, rework, weather, equipment availability, and labor availability.

- **Site logistics:** Space constraints will limit equipment placement, size, and movement and lead to additional decrease in construction productivity.
- **Other transportation projects:** Lack of coordination with other Metrorail capital projects could limit Metro’s ability to schedule single-tracking and station closures and lead to construction delay.
- **Additional community amenities:** Project partners may agree to the community's requests for enhanced post-construction amenities that will impact cost and schedule (e.g. station finishes, landscaping, etc.).
- **Impacts to adjacent uses:** May require mitigation that may delay the contractor when the full crew is on site, resulting in stop work orders, claims, etc.
- **Public safety incidents:** These can include fire and smoke incidents that arise during construction and result in additional cost and schedule delay.

6 Schedule

A construction schedule was developed based on the preliminary sequence of construction described below. The anticipated construction duration is 24 months. **Table 5** presents a summary of the conceptual project schedule. The conceptual schedule identifies the critical path activities that may be done concurrently. **Appendix D** provides the detailed conceptual project schedule.

Table 5 | Overview of Construction Schedule

Activity	Duration
Agreements	12 months
Design	12 months
Bidding	4 months
Permits and Easements	12 months
Procurement	12 months
Submittals	4 months
Construction	24 months

The following assumptions in developing the conceptual schedules are subject to refinement in future design and engineering work:

- Project delivery is Design/Bid/Build.
- Project is not a phased approach.

- Construction cannot begin until necessary permits are obtained. Prior tasks are:
 - Identifying jurisdictions involved and permits required, including the MOT Plan.
 - Identifying existing adjacent uses, including auto, pedestrian, and bike traffic.
 - Identifying access considerations for adjacent properties, such as parking garages.
- Construction activities that require access to tracks and platforms will occur during non-revenue hours and selected weekends.

6.1 Schedule Drivers

The schedule drivers include:

- The **interface agreement between Metro and the developer** needs to address several key aspects and requires timely execution.
- The **design** defines the scope, schedule and cost of the project, and identifies contract package(s) and long-lead items.
- **Support of Excavation:** Construction of the second entrance requires SOE for the new mezzanine shell as well as the new elevator machine room for the mezzanine-to-westbound platform elevator. Metro should define what can and cannot be done during construction.
- **Structural modifications:** This work includes vault openings, end wall opening, floor slab openings, and mezzanine construction.
- **ME systems:** Equipment will be installed to support critical functions for continuous service, including signals, communications, fire life safety, passenger information systems, traction power supply, and other ME functions that are resident in the station. Also, the ME systems work to support the construction phase needs to be completed before construction activities requiring access to the station platform begin.
- **Rail operations:** Rail operations will need to be closely coordinated with construction activities. Mezzanine construction will affect passenger access to the east end of the platform; this analysis assumes limiting construction to non-revenue hours and selected weekends.

